



LI-TIAN LIGHTING



ARCHITECTURAL&LANDSCAPE LIGHTING



LI-TIAN LIGHTING



PROJECTORS

FOR OUTDOOR APPLICATIONS

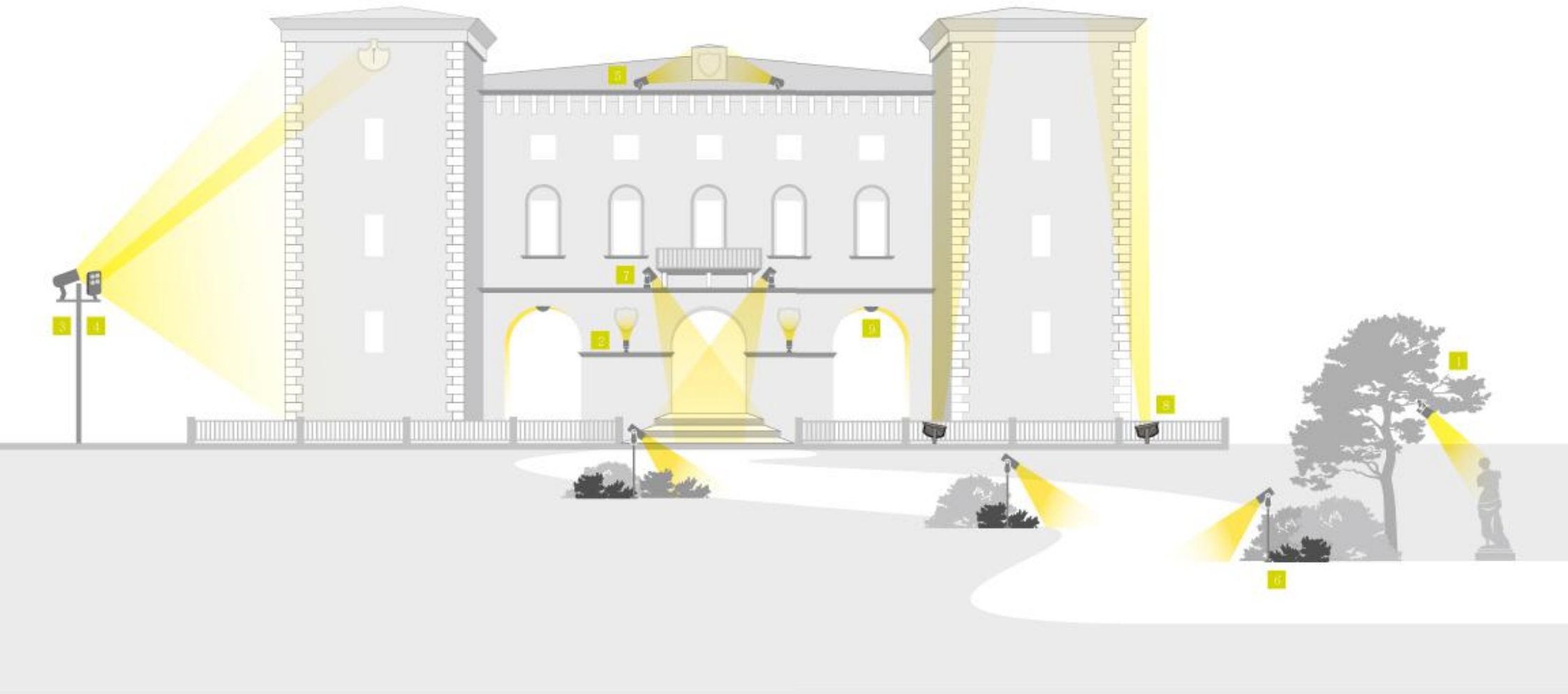

ROSE

LT-SL-series

UNIQUE SELLING POINTS

IK08

BODY IN DIE-CAST
LOW-COPPER-
CONTENT
ALUMINIUM EN AB
47100 FOR EXCELLENT
RESISTANCE TO
CORROSION

4-MM-THICK TRANSPARENT EXTRA-CLEAR
GLASS WITH VITRIFIED
SERIGRAPHY, HIGH
TRANSMITTANCE TO ENSURE
CHROMATIC UNIFORMITY AND
TEMPERED FOR EXCELLENT
RESISTANCE
TO KNOCKS AND SCRATCHES

5 kinds of light distribution



RAL FINISH
ON REQUEST

IP66

SUITABLE
FOR OUTDOOR
APPLICATIONS

316 stainless
steel fasteners

SCALED, ADJUSTABLE
BRACKET

1/2" NPT thread. A fully sealed
spherical grommet allows infinite
adjustment capabilities



20 installation
combinations



LI-TIAN LIGHTING

LT-SL -series

ROSE 1.1
10-20W, optical range 15°-60°

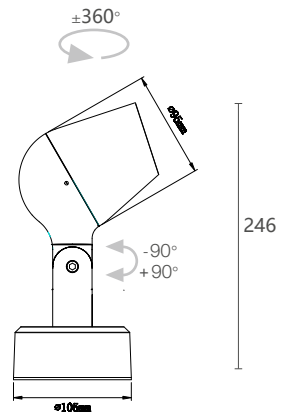

CE LED kg 1.2 IP66 IK08
A A+ A++ RAL



POWER / POWER SUPPLY	10W / 15W / 20W AC220V-240V or (120-277V) Powder coating: bronze (DC12-24V)
CRI	CRI >90
LED COLOUR	- 2700K - 3000K - 4000K
OPTICS	- optical range 15° / 23° / 36° / 60° / 40*70°
LUMEN OUTPUT AT SOURCE	1000lm / 1500lm / 2000lm (4000K, CRI 90)
NO. AND TYPE OF LED	1 COB high-intensity power LED 3-step MacAdam, 50000h L90 B10 (Ta 25°C)
MATERIAL	body in Powder coating anticorodal aluminium screen in tempered, transparent extra-clear glass
POWER CABLES	neoprene cable 3x0.75
MOUNTING	surface mounted (ceiling, wall, ground, spike, pole)
NOTES	Honeycomb louvre available on request



LI-TIAN LIGHTING

LT-SL -series

ROSE 1.2
30-60W, optical range 15°-60°

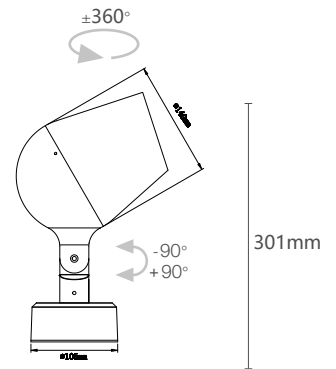

CE LED kg 2 IP66 IK08
A A+ A++ RAL

POWER / POWER SUPPLY	30W / 40W / 60W AC220V-240V or (120-277V) Powder coating: bronze (DC12-24V)
CRI	CRI >90
LED COLOUR	- 2700K - 3000K - 4000K
OPTICS	- optical range 15° / 23° / 36° / 60° / 40*70°
LUMEN OUTPUT AT SOURCE	3000lm / 4000lm / 6000lm (4000K, CRI 90)
NO. AND TYPE OF LED	1 COB high-intensity power LED 3-step MacAdam, 50000h L90 B10 (Ta 25°C)
MATERIAL	body in Powder coating anticorodal aluminium screen in tempered, transparent extra-clear glass
POWER CABLES	neoprene cable 3x0.75
MOUNTING	surface mounted (ceiling, wall, ground, spike, pole)
NOTES	Honeycomb louvre available on request



LI-TIAN LIGHTING

LT-SL -series

ROSE 1.3
9/36W, optical range 15°-60°

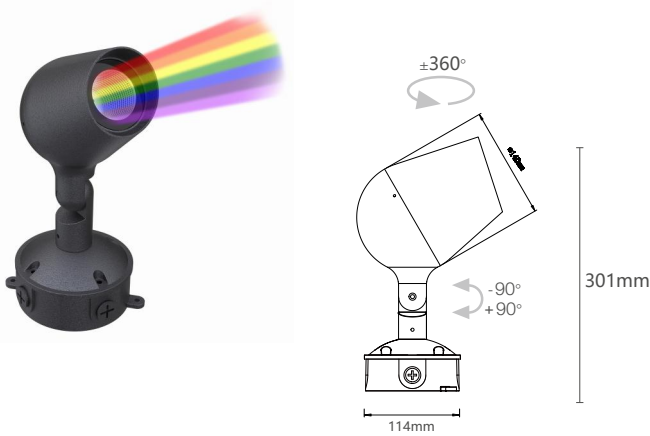

RGBW
CE LED TECH III kg 1.2 IP66 IK08
A A+ A++ RAL



RGBW
CE LED TECH III kg 2 IP66 IK08
A A+ A++ RAL

POWER / POWER SUPPLY	9W DC24V Powder coating: bronze
LED COLOUR	- RGBW DMX512
OPTICS	- optical range 15° / 23° / 36° / 60°
LUMEN OUTPUT AT SOURCE	536 lm, R: 83 lm G: 150 lm B: 60 lm W: 243 lm (4000K)
NO. AND TYPE OF LED	2 RGBW LED groups 50000h L90 B10 (Ta 25°C)
MATERIAL	body in Powder coating anticorodal aluminium screen in tempered, transparent extra-clear glass
POWER CABLES	neoprene cable 3x0.3mm ² (DMX line) and 2x1mm ² (DC line) Ø6.3 mm
MOUNTING	surface mounted (ceiling, wall, ground, spike, pole)
NOTES	Honeycomb louvre available on request

POWER / POWER SUPPLY	36W DC24V Powder coating: bronze
LED COLOUR	- RGBW DMX512
OPTICS	- optical range 15° / 23° / 36° / 60°
LUMEN OUTPUT AT SOURCE	2148 lm, R: 336 lm G: 594 lm B: 238 lm W: 980 lm (4000K)
NO. AND TYPE OF LED	8 RGBW LED groups 50000h L90 B10 (Ta 25°C)
MATERIAL	body in Powder coating anticorodal aluminium screen in tempered, transparent extra-clear glass
POWER CABLES	neoprene cable 3x0.3mm ² (DMX line) and 2x1mm ² (DC line) Ø6.3 mm
MOUNTING	surface mounted (ceiling, wall, ground, spike, pole)
NOTES	Honeycomb louvre available on request



ROSE

ACCESSORIES

**Options
ACCESSORIES**

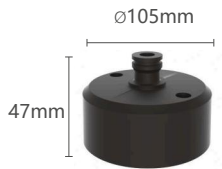

SB Surface Base Mount



JB Junction Box(USA)

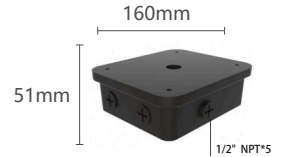
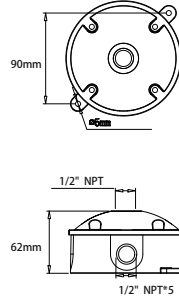

WM Wall Mount(USA)



Extension arm L:500mm(φ 25mm)
Material: AL

* Can be customized in different lengths

**OPTICAL
ACCESSORIES**



Honeycomb louvre
built into the
lighting fixture

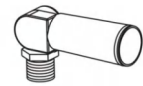

Photocell option
Swivel photocell available



LI-TIAN LIGHTING

LT-SL -series

ROSE 1.4
10-20W, optical range 15°-60°



CE LED kg 2 IP66 IK08
A A+ A++ RAL

POWER / POWER SUPPLY	10W / 15W / 20W AC220V-240V or (120-277V) Powder coating: bronze (DC12-24V)
CRI	CRI >90
LED COLOUR	- 2700K - 3000K - 4000K
OPTICS	- optical range 15° / 23° / 36° / 60° / 40*70°
LUMEN OUTPUT AT SOURCE	1000lm / 1500lm / 2000lm (4000K, CRI 90)
NO. AND TYPE OF LED	1 COB high-intensity power LED 3-step MacAdam, 50000h L90 B10 (Ta 25°C)
MATERIAL	body in Powder coating anticorrosion aluminium screen in tempered, transparent extra-clear glass
POWER CABLES	neoprene cable 3x0.75
MOUNTING	surface mounted (ceiling, wall, ground, spike, pole)
NOTES	Honeycomb louvre available on request

ROSE

ACCESSORIES

**Options
ACCESSORIES**

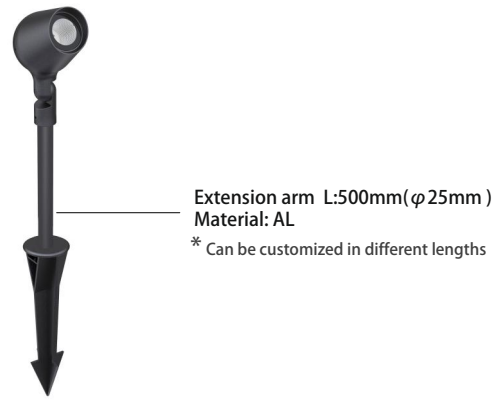
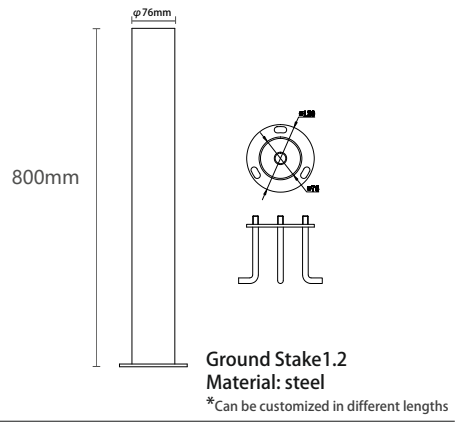
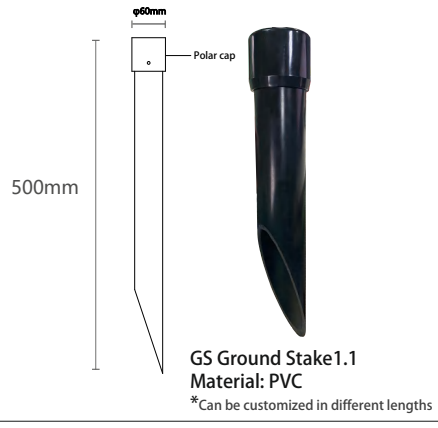

**OPTICAL
ACCESSORIES**

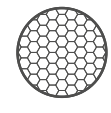

Honeycomb louvre
built into the
lighting fixture



LI-TIAN LIGHTING

LT-SL-10W-3000K

S - 15° CRI 90

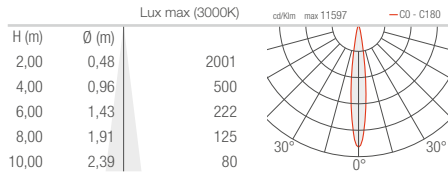

L - 36° CRI 90

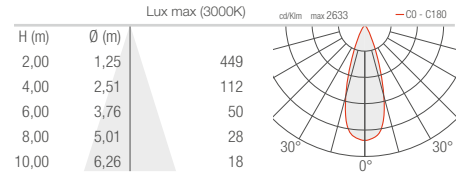

M - 20° CRI 90

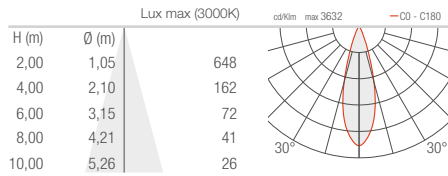

K - 60° CRI 90

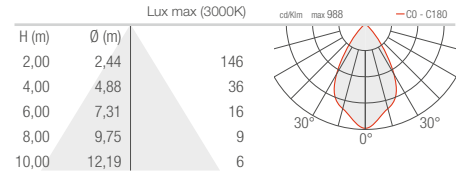

LT-SL-15W-3000K

S - 15° CRI 90

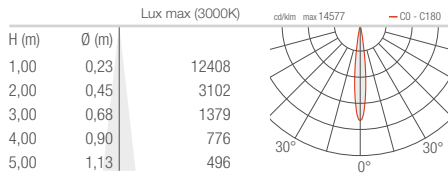

L - 36° CRI 90

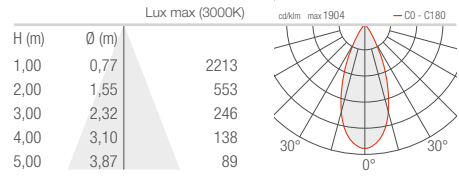

M - 20° CRI 90

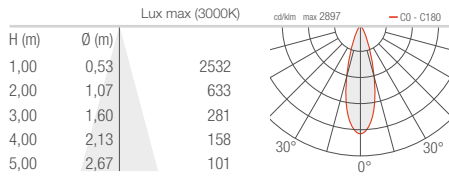

J - 60° CRI 90

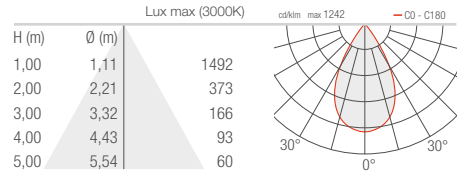

LT-SL-20W-3000K

S - 15° CRI 90

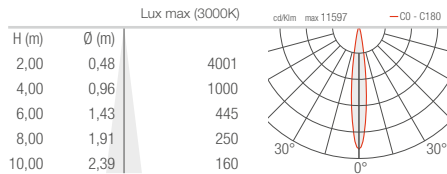

L - 36° CRI 90

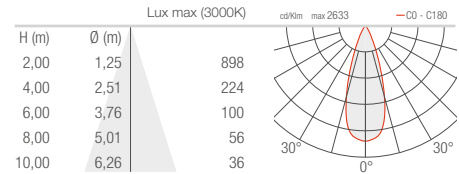

M - 20° CRI 90

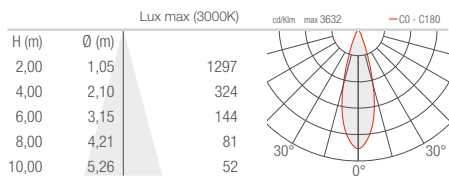

K - 60° CRI 90

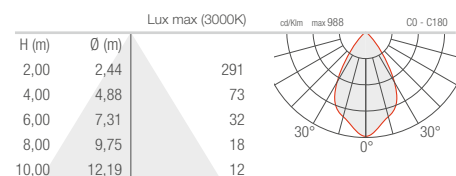



LI-TIAN LIGHTING

LT-SL-30W-3000K

S - 15° CRI 90

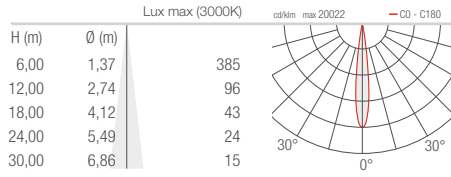

M - 23° CRI 90

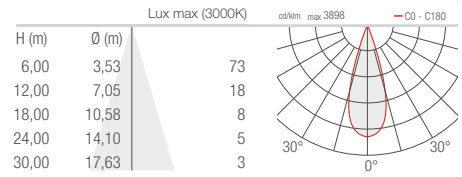

L - 36° CRI 90

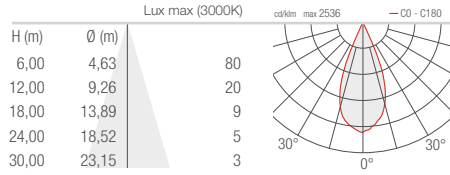

LT-SL-40W-3000K

S - 15° CRI 90

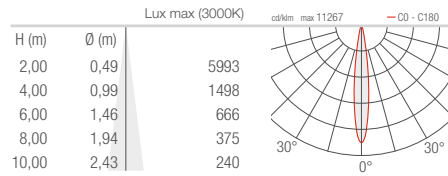

M - 23° CRI 90

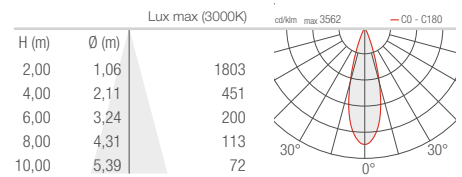

L - 36° CRI 90

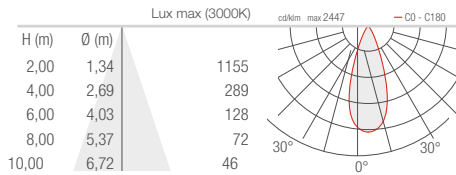



LI-TIAN LIGHTING

LT-SL -series

v
ROSE 1.5
30-60W, optical range 15°-60°

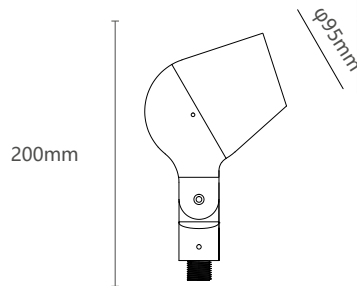

CE LED kg 2 IP66 IK08
A A+ A++ RAL

POWER / POWER SUPPLY	10W / 15W / 20W AC220V-240V or (120-277V) Powder coating: bronze (DC12-24V)
CRI	CRI >90
LED COLOUR	- 2700K - 3000K - 4000K
OPTICS	- optical range 15° / 23° / 36° / 60° / 40*70°
LUMEN OUTPUT AT SOURCE	1000lm / 1500lm / 2000lm (4000K, CRI 90)
NO. AND TYPE OF LED	1 COB high-intensity power LED 3-step MacAdam, 50000h L90 B10 (Ta 25°C)
MATERIAL	body in Powder coating anticorrosion aluminium screen in tempered, transparent extra-clear glass
POWER CABLES	neoprene cable 3x0.75
MOUNTING	surface mounted (ceiling, wall, ground, spike, pole)
NOTES	Honeycomb louvre available on request



LI-TIAN LIGHTING

ROSE

ACCESSORIES

Options ACCESSORIES



TM Tree Mount 1.0
Material: Polyester + aluminum
length:2m

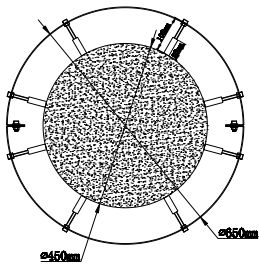
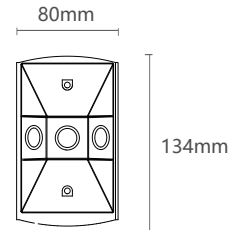
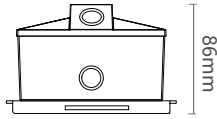

TRM Tree ring Mount 1.1
Material: 304 stainless steel

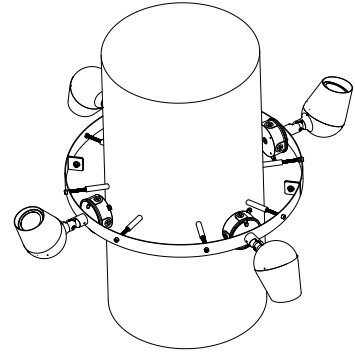
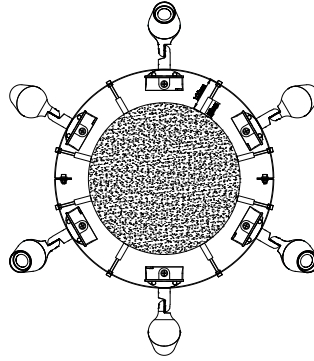



LI-TIAN LIGHTING

LT-SL -series

ROSE 1.6
30-60W, optical range 15°-60°



CE LED
IP66 IK08
A A+ A++ RAL

POWER / POWER SUPPLY	30W/pcs 40W/pcs 60W/pcs Powder coating: bronze	AC220V-240V or (120-277V) (DC12-24V)
CRI	CRI >90	
LED COLOUR	- 2700K - 3000K - 4000K	
OPTICS	- optical range 15° / 23° / 36° / 60° / 40*70°	
LUMEN OUTPUT AT SOURCE	3000lm / 4000lm / 6000lm (4000K, CRI 90)	
NO. AND TYPE OF LED	1 COB high-intensity power LED 3-step MacAdam, 50000h L90 B10 (Ta 25°C)	
MATERIAL	body in Powder coating anticorodal aluminium screen in tempered, transparent extra-clear glass	
POWER CABLES	neoprene cable 3x0.75	
MOUNTING	surface mounted (ceiling, wall, ground, spike, pole)	
NOTES	Honeycomb louvre available on request	

Options ACCESSORIES

Flange (Unilateral)



Flange (Bilateral)

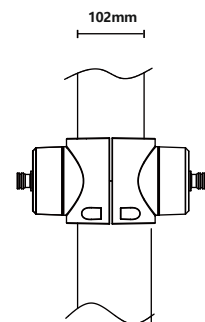

Material: die-cast aluminum



LI-TIAN LIGHTING

LT-SL -series

ROSE 1.7
30-60W, optical range 15°-60°



CE LED IP66 IK08
A A+ A++ RAL

POWER / POWER SUPPLY	30W/pcs 40W/pcs 60W/pcs Powder coating: bronze	AC220V-240V or (120-277V) (DC12-24V)
CRI	CRI >90	
LED COLOUR	- 2700K - 3000K - 4000K	
OPTICS	- optical range 15° / 23° / 36° / 60° / 40*70°	
LUMEN OUTPUT AT SOURCE	3000lm / 4000lm / 6000lm (4000K, CRI 90)	
NO. AND TYPE OF LED	1 COB high-intensity power LED 3-step MacAdam, 50000h L90 B10 (Ta 25°C)	
MATERIAL	body in Powder coating anticorodal aluminium screen in tempered, transparent extra-clear glass	
POWER CABLES	neoprene cable 3x0.75	
MOUNTING	surface mounted (ceiling, wall, ground, spike, pole)	
NOTES	Honeycomb louvre available on request	

Options ACCESSORIES



Arm for pole mounting
Material: die-cast aluminum

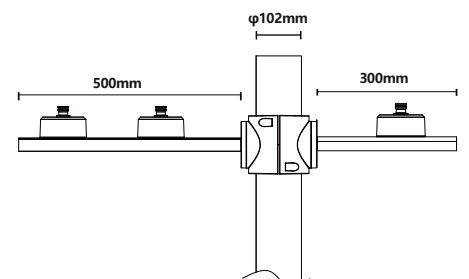



LI-TIAN LIGHTING

LT-SL -series

√
ROSE 1.8
30-60W, optical range 15°-60°



CE LED LEPV IP66 IK08
A A+ A++ RAL

POWER / POWER SUPPLY	30W/pcs 40W/pcs 60W/pcs	AC220V-240V or (120-277V) (DC12-24V)
	Powder coating: bronze	
CRI	CRI >90	
LED COLOUR	- 2700K - 3000K - 4000K	
OPTICS	- optical range 15° / 23° / 36° / 60° / 40*70°	
LUMEN OUTPUT AT SOURCE	3000lm / 4000lm / 6000lm (4000K, CRI 90)	
NO. AND TYPE OF LED	1 COB high-intensity power LED 3-step MacAdam, 50000h L90 B10 (Ta 25°C)	
MATERIAL	body in Powder coating anticorodal aluminium screen in tempered, transparent extra-clear glass	
POWER CABLES	neoprene cable 3x0.75	
MOUNTING	surface mounted (ceiling, wall, ground, spike, pole)	
NOTES	Honeycomb louvre available on request	

Options ACCESSORIES



Coupler
Material: Aluminum alloy
Suitable for φ60-200mm pole

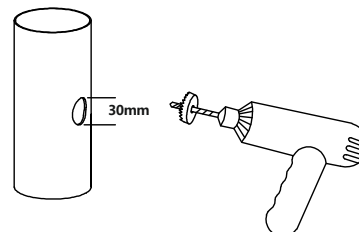



LI-TIAN LIGHTING

LT-SL -series

ROSE 1.9
30-60W, optical range 15°-60°



CE LED ENEC IP66 IK08
A A+ A++ RAL

POWER / POWER SUPPLY	30W/pcs 40W/pcs 60W/pcs Powder coating: bronze	AC220V-240V or (120-277V) (DC12-24V)
CRI	CRI >90	
LED COLOUR	- 2700K - 3000K - 4000K	
OPTICS	- optical range 15° / 23° / 36° / 60° / 40*70°	
LUMEN OUTPUT AT SOURCE	3000lm / 4000lm / 6000lm (4000K, CRI 90)	
NO. AND TYPE OF LED	1 COB high-intensity power LED 3-step MacAdam, 50000h L90 B10 (Ta 25°C)	
MATERIAL	body in Powder coating anticorodal aluminium screen in tempered, transparent extra-clear glass	
POWER CABLES	neoprene cable 3x0.75	
MOUNTING	surface mounted (ceiling, wall, ground, spike, pole)	
NOTES	Honeycomb louvre available on request	

Options ACCESSORIES

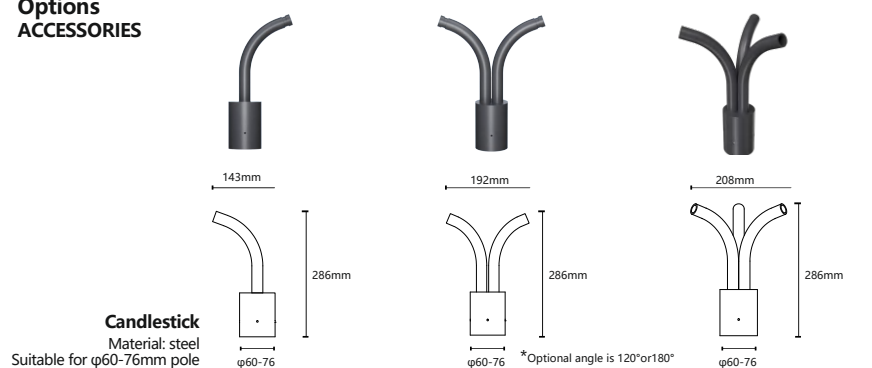



LI-TIAN LIGHTING

LT-SL -series

LED BOLLARD LIGHT
ROSE 1.9
20W, optical range 60° or 40*70°

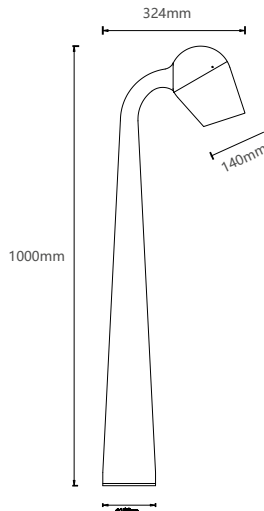

CE LED kg 2 IP66 IK08
A A+ A++ RAL



POWER / POWER SUPPLY	20W Powder coating: bronze	AC220V-240V or (120-277V) (DC12-24V)
CRI	CRI >90	
LED COLOUR	- 2700K - 3000K - 4000K	
OPTICS	- optical range 60° / 40*70°	
LUMEN OUTPUT AT SOURCE	2000lm (4000K, CRI 90)	
NO. AND TYPE OF LED	1 COB high-intensity power LED 3-step MacAdam, 50000h L90 B10 (Ta 25°C)	
MATERIAL	body in Powder coating anticorodal aluminium screen in tempered, transparent extra-clear glass	
POWER CABLES	neoprene cable 3x0.75	
MOUNTING	buried base or flange plate	
NOTES	Honeycomb louvre available on request	

Options ACCESSORIES

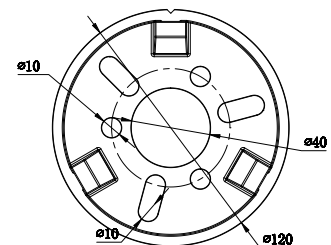
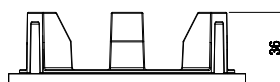

Flange plate

Material: Die-cast aluminum



LI-TIAN LIGHTING

LT-SL -series

LED BOLLARD LIGHT
ROSE 2.0
7W, optical range 15°

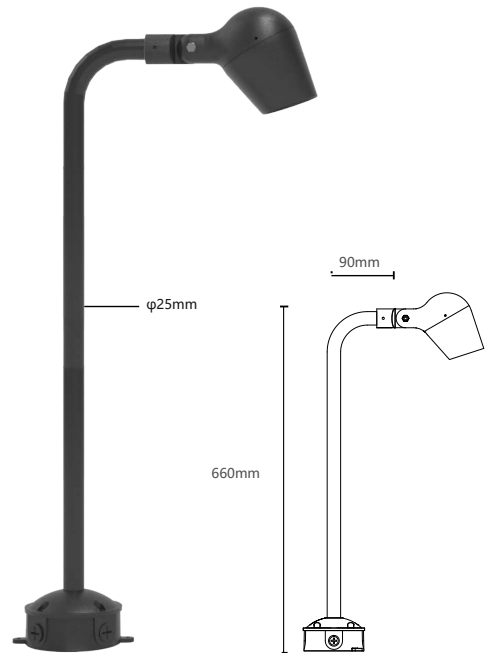

POWER / POWER SUPPLY	7W Powder coating: bronze	AC220V-240V or (120-277V) (DC12-24V)
CRI	CRI >90	
LED COLOUR	- 2700K - 3000K - 4000K	
OPTICS	- optical range 15° / 23° / 36° / 60° / 40*70°	
LUMEN OUTPUT AT SOURCE	700lm (4000K, CRI 90)	
NO. AND TYPE OF LED	1 COB high-intensity power LED 3-step MacAdam, 50000h L90 B10 (Ta 25°C)	
MATERIAL	body in Powder coating anticorodal aluminium screen in tempered, transparent extra-clear glass	
POWER CABLES	neoprene cable 3x0.75	
MOUNTING	surface mounted (ceiling, wall, ground, spike, pole)	
NOTES	Honeycomb louvre available on request	

Accessories



Extension arm



JB Junction Box

Material: Aluminum profile
Specification: Thickness 4mm, φ25mm
***Length can be customized**



BOLLARDS AND URBAN LIGHTING

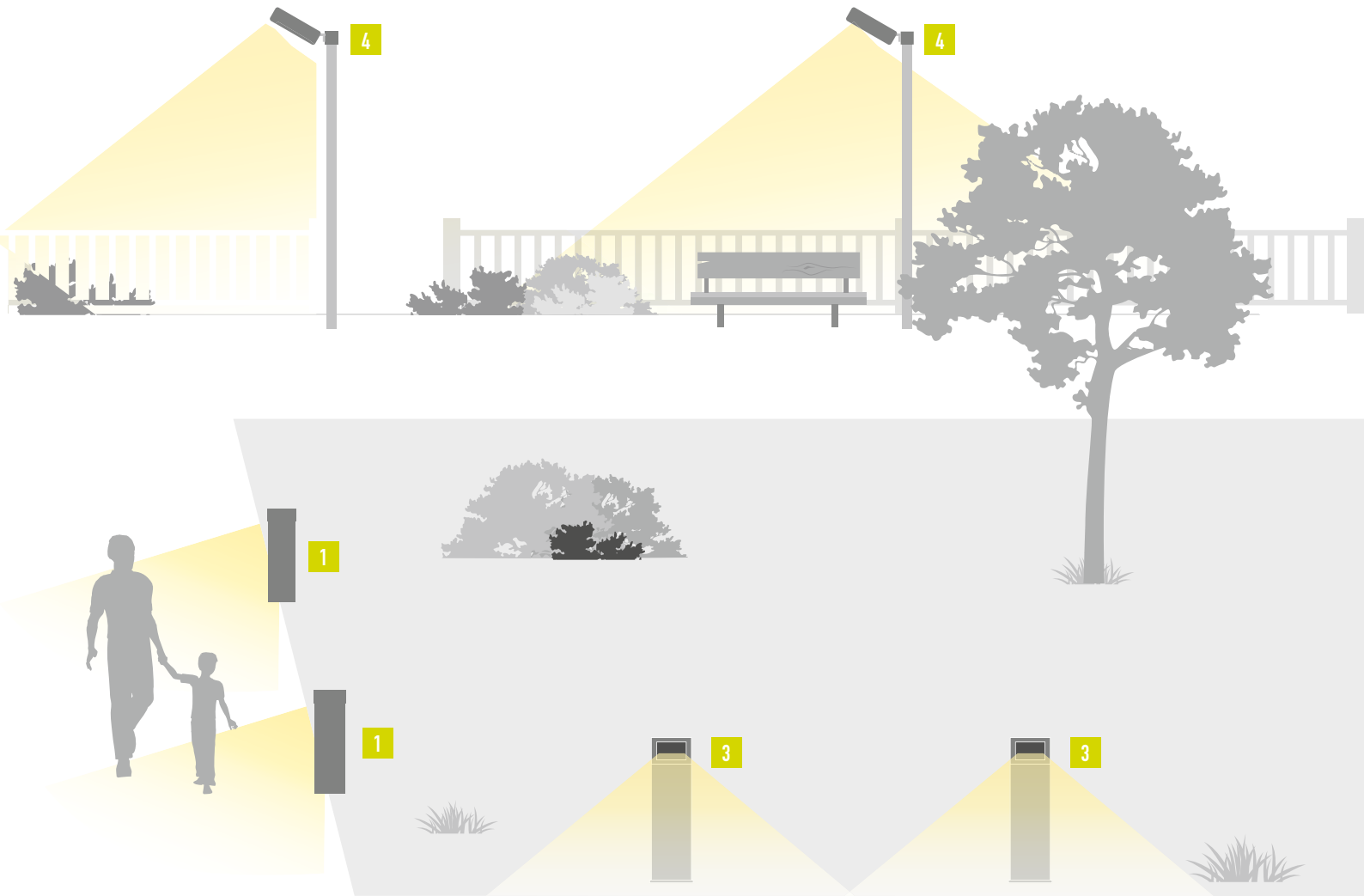

BOLLARD LIGHT

Upper cover
Corrosion-resistant cast aluminium, No-Rinse surface treatment
Graphit m, double powder-coated

Module
High-power LEDs: warm white (3000K) or neutral white (4000K)

IK06

IP66

IESNA Type II (medium) beam, applicable for European P-class standard pedestrian lighting and M-class roads

Anti-glare cone
Corrosion-resistant cast aluminium, No-Rinse surface treatment
Double powder-coated and black lacquered.
Glare-free above the light aperture



RAL FINISH
ON REQUEST

Material
4mm aluminum profile

316 stainless steel fasteners

Base plate
For mounting on accessories





LI-TIAN LIGHTING

UNIQUE SELLING POINT

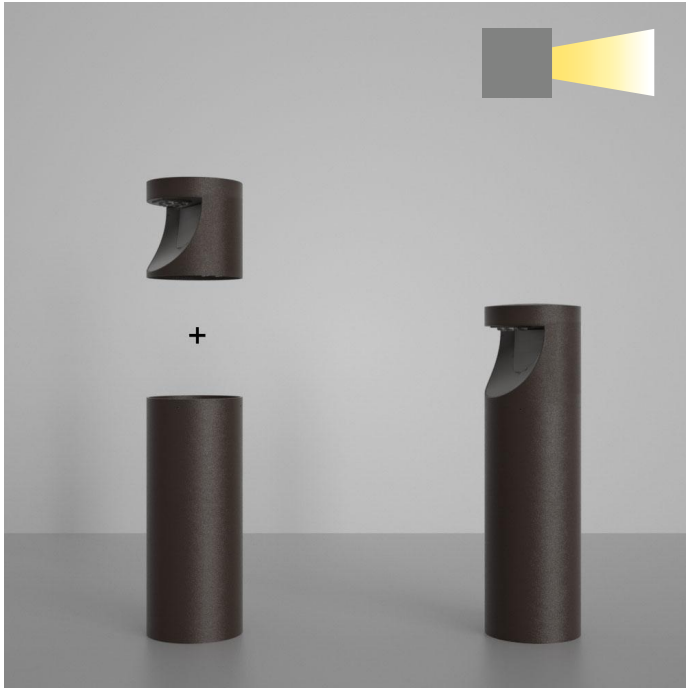

Single

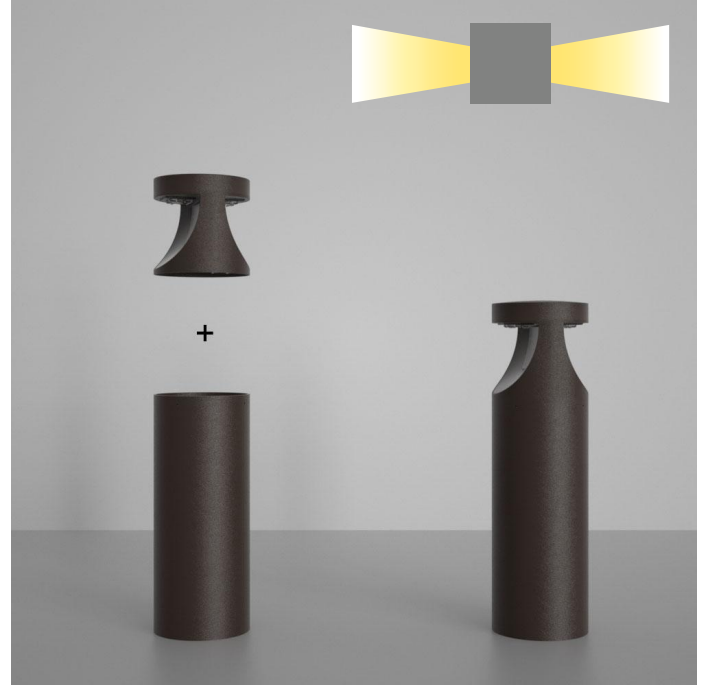

Double

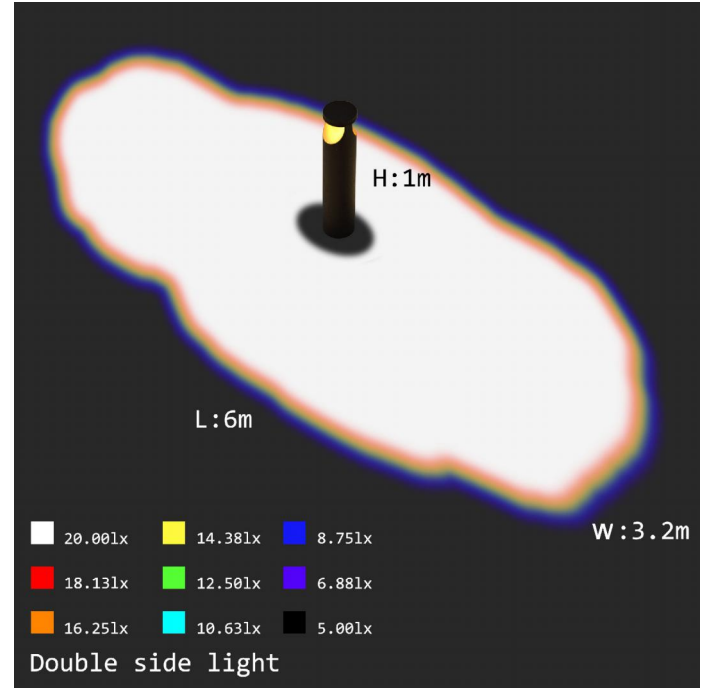
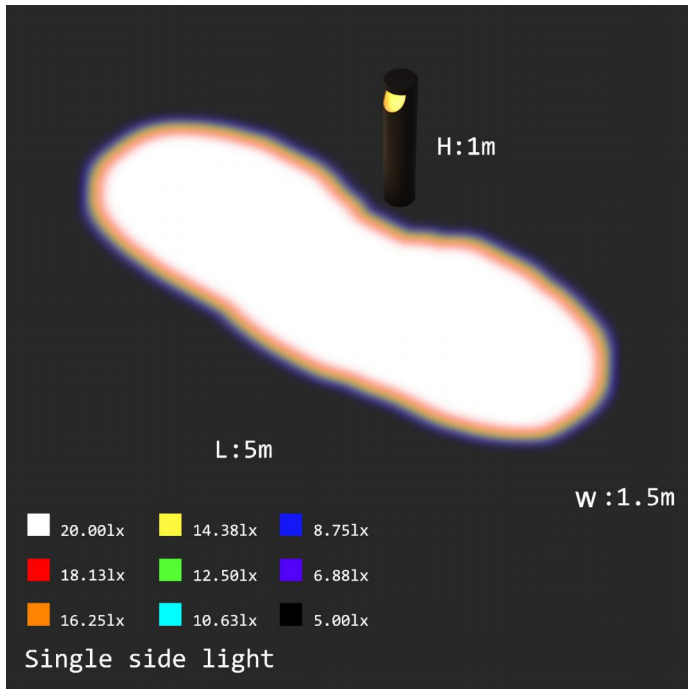

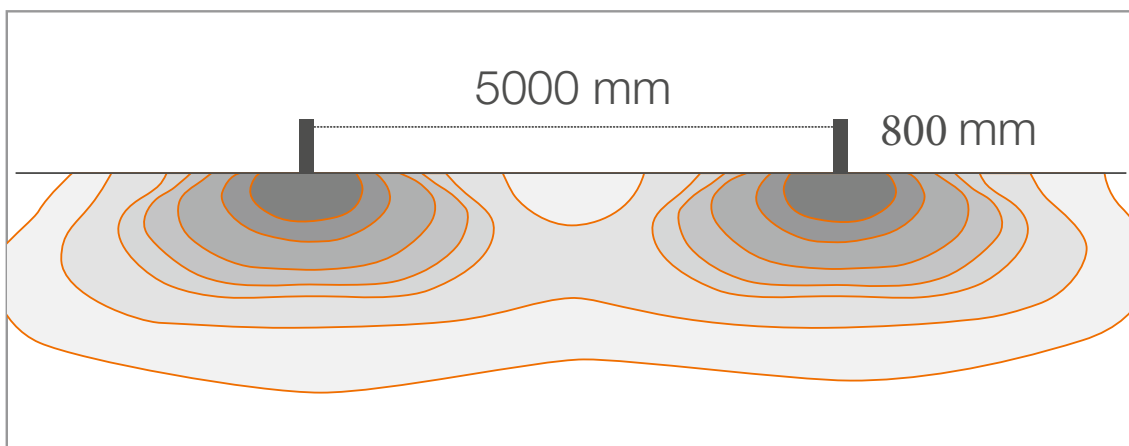

Asymmetrical diffuse

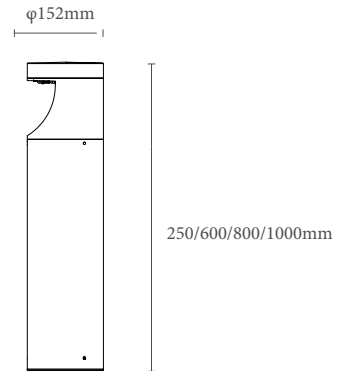

LAUGH

LT-BL-12W-3000K-60L







 kg 2.77 h 250 mm
 kg 4.05 h 600 mm
 kg 4.82 h 800 mm
 kg 5.51 h 1000 mm



IP66 IK06

POWER / POWER SUPPLY CODE	12W AC220V-240V or (120-277V)
LED COLOUR	- 2700K - 3000K - 4000K
OPTICS	asymmetrical
LUMEN OUTPUT AT SOURCE	960 lm (4000K, 12W)
NO. AND TYPE OF LED	4 high-intensity power LEDs 3-step MacAdam (version 24W) 50000h L90 B10 (Ta 25°C)
MATERIAL	Corrosion-resistant aluminium profile, No-Rinse surface treatment and Die-cast aluminum module.
POWER SUPPLY UNIT	built in
POWER CABLES	neoprene cable 3x0.75mm ²
MOUNTING	buried base or flange plate
NOTES	non-standard heights available on request

Optional Accessories

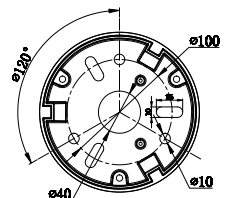
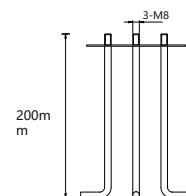

Material: steel
*Need to be purchased separately

Flange plate(Die-cast aluminum)
*Standard configuration

LAUGH

LT-BL-24W-3000K-60L

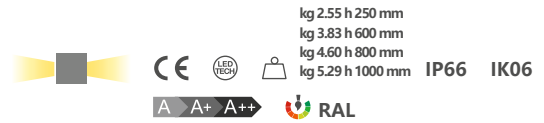
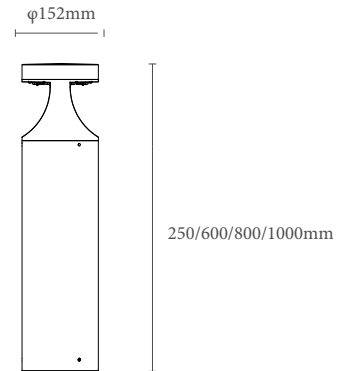

kg 2.55 h 250 mm
kg 3.83 h 600 mm
kg 4.60 h 800 mm
kg 5.29 h 1000 mm

POWER / POWER SUPPLY CODE	24W AC220V-240V or (120-277V)
LED COLOUR	- 2700K - 3000K - 4000K
OPTICS	asymmetrical
LUMEN OUTPUT AT SOURCE	1920 lm (4000K, 24W)
NO. AND TYPE OF LED	8 high-intensity power LEDs 3-step MacAdam (version 24W) 50000h L90 B10 (Ta 25°C)
MATERIAL	Corrosion-resistant aluminium profile, No-Rinse surface treatment and Die-cast aluminum module.
POWER SUPPLY UNIT	built in
POWER CABLES	neoprene cable 3x0.75mm ²
MOUNTING	buried base or flange plate
NOTES	non-standard heights available on request

Optional Accessories

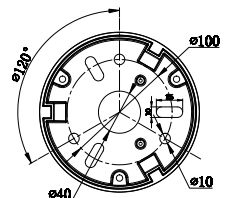
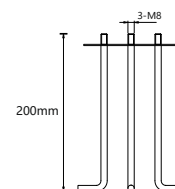

Material: steel
*Need to be purchased separately

Flange plate(Die-cast aluminum)
*Standard configuration



LT-BL-12W-3000K-60L

INTENSITY DISTRIBUTION DIAGRAM
IN C PLANS

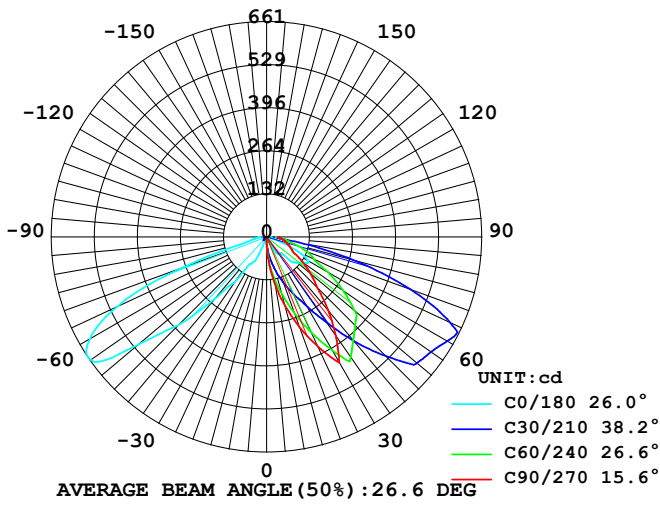

LT-BL-24W-3000K-60L

INTENSITY DISTRIBUTION DIAGRAM
IN C PLANS

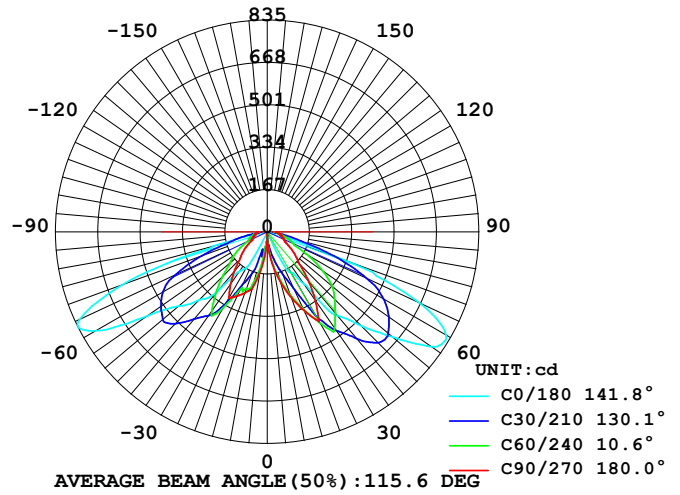

AVERAGE AND CENTER E Figure

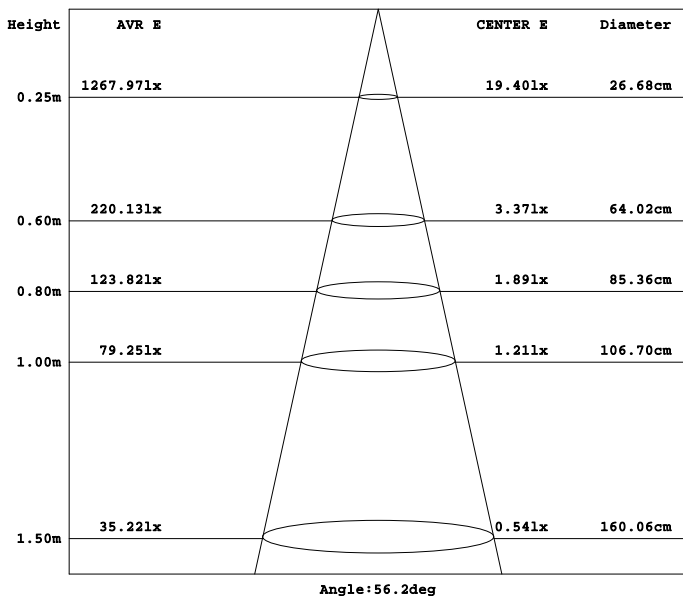

AVERAGE AND CENTER E Figure

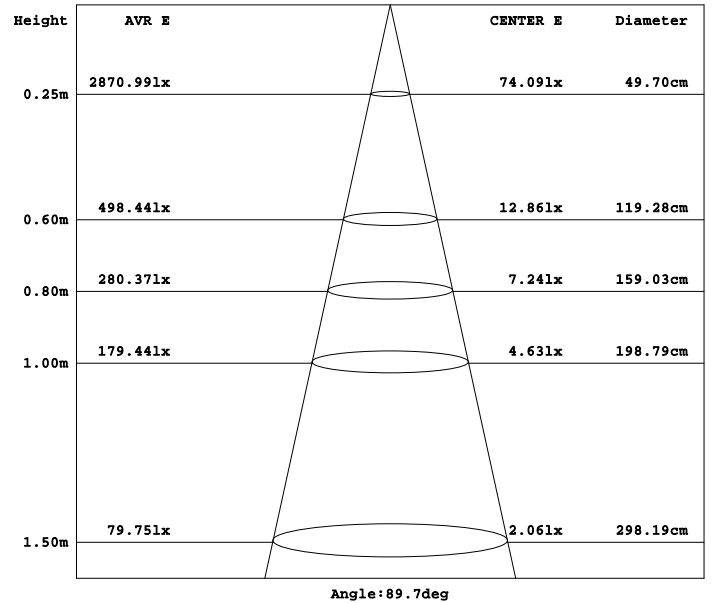



LI-TIAN LIGHTING

LED Light Column

LT-PT-DH-24W-3000K
LT-PT-DH-36W-3000K

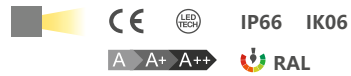

POWER / POWER SUPPLY CODE	24W AC220V-240V or (120-277V) 36W
LED COLOUR	- 2700K - 3000K - 4000K
OPTICS	asymmetrical
LUMEN OUTPUT AT SOURCE	1920 / 2880lm (4000K, 24W/36W)
NO. AND TYPE OF LED	8/12high-intensity power LEDs 3-step MacAdam (version 24W) 50000h L90 B10 (Ta 25°C)
MATERIAL	Corrosion-resistant aluminium profile, No-Rinse surface treatment and Die-cast aluminum module.
POWER SUPPLY UNIT	built in
POWER CABLES	neoprene cable 3x0.75mm ²
MOUNTING	buried base
NOTES	non-standard heights available on request
SIZE	φ152mm H:3m/H3.5m
OVERVOLTAGE PROTECTION	10kV in Common Mode (CM), 6kV in Differential Mode (DM)

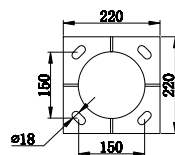

Anchor bolt

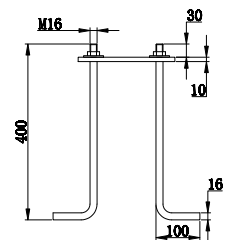



LI-TIAN LIGHTING

LED Light Column

LT-PT-SH-48W-3000K
LT-PT-SH-72W-3000K

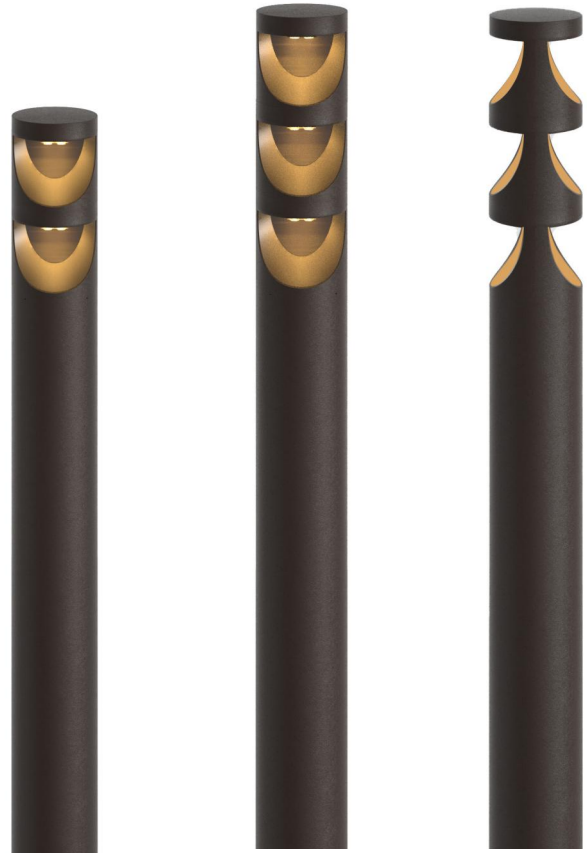

POWER / POWER SUPPLY CODE	48W AC220V-240V or (120-277V) 72W
LED COLOUR	- 2700K - 3000K - 4000K
OPTICS	asymmetrical
LUMEN OUTPUT AT SOURCE	3840 / 5760lm (4000K, 48W/72W)
NO. AND TYPE OF LED	16/24high-intensity power LEDs 3-step MacAdam (version 48W) 50000h L90 B10 (Ta 25°C)
MATERIAL	Corrosion-resistant aluminium profile, No-Rinse surface treatment and Die-cast aluminum module.
POWER SUPPLY UNIT	built in
POWER CABLES	neoprene cable 3x0.75mm ²
MOUNTING	buried base
NOTES	non-standard heights available on request
SIZE	φ152mm H:3m/H3.5m
OVERVOLTAGE PROTECTION	10kV in Common Mode (CM), 6kV in Differential Mode (DM)

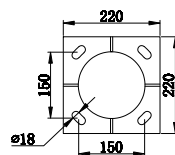

Anchor bolt

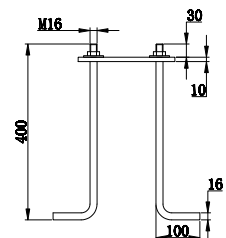



LT-PT-SH-48W-3000K

INTENSITY DISTRIBUTION DIAGRAM
IN C PLANS

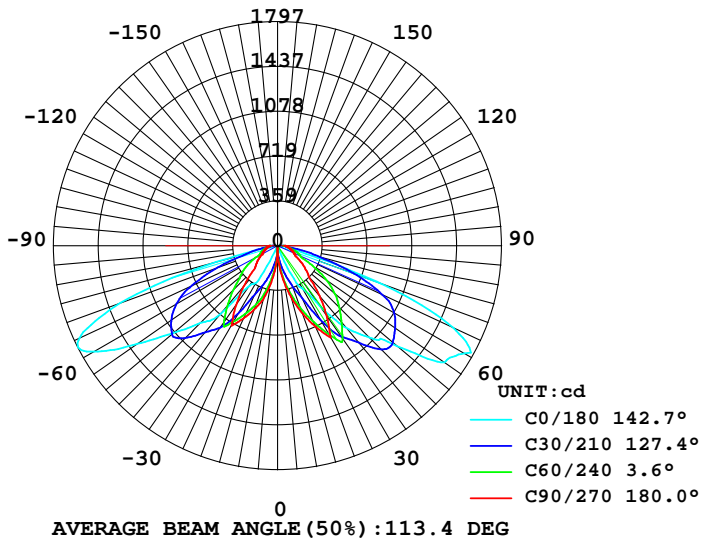

AVERAGE AND CENTER E Figure

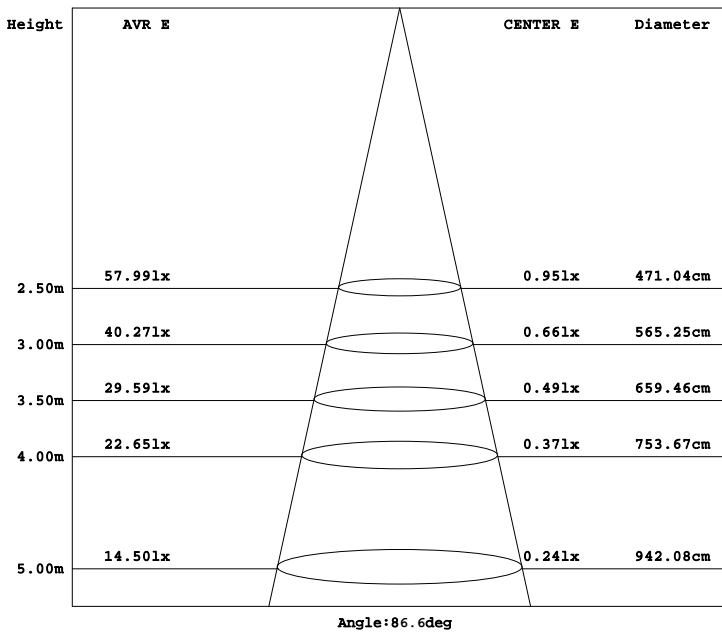

Eclipse Family





Upper cover

Corrosion-resistant cast aluminium, No-Rinse surface treatment
Graphit m, double powder-coated

light guiding ring

Made of glass

LED-module

High-power LEDs: warm white (3000K) or neutral white (4000K)

Anti-glare cone

Corrosion-resistant cast aluminium, No-Rinse surface treatment
Double powder-coated and black lacquered.
Glare-free above the light aperture

Bollard

Graphit m
Corrosion-resistant aluminium profile, No-Rinse surface treatment
Double powder-coated
Optimised surface for reduced accumulation of dirt

Base plate

For mounting on accessories
Mounting accessories to be ordered separately

Eclipse

√
Eclipse 1.1
LT-YS-12W-3000K

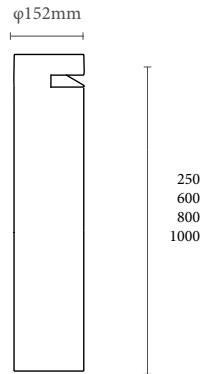

CE LED TECH IP65 IK09
A A+ A++ RAL

POWER / POWER SUPPLY CODE 12W AC220V-240V or (120-277V)
; : () \$ +M

LED COLOUR - 2700K
- 3000K
- 4000K

OPTICS symmetry

LUMEN OUTPUT AT SOURCE 497 lm (4000K, () W)

NO. AND TYPE OF LED 24high-intensity power LEDs 3-step MacAdam (version 24W) 50000h L90 B10 (Ta 25°C)

MATERIAL Corrosion-resistant aluminium profile, No-Rinse surface treatment and Die-cast aluminum module.

POWER SUPPLY UNIT built in

POWER CABLES neoprene cable 3x0.75mm²

MOUNTING buried base or flange plate

NOTES non-standard heights available on request

Optional Accessories

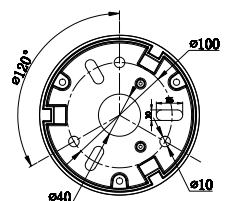
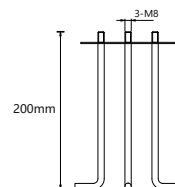

Material: steel
*Need to be purchased separately

Flange plate(Die-cast aluminum)
*Standard configuration

Eclipse

√
Eclipse 1.2
LT-YS-24W-3000K

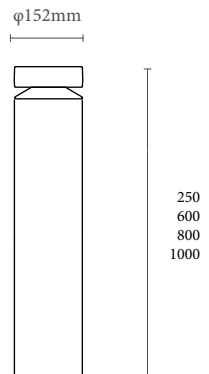

IP65 IK09

A A+ A++



POWER / POWER SUPPLY CODE 24W AC220V-240V or (120-277V)
; : () \$ +M

LED COLOUR - 2700K
- 3000K
- 4000K

OPTICS asymmetric

LUMEN OUTPUT AT SOURCE 820lm (4000K,) 4W)

NO. AND TYPE OF LED 48high-intensity power LEDs 3-step MacAdam (version 24W) 50000h L90 B10 (Ta 25°C)

MATERIAL Corrosion-resistant aluminium profile, No-Rinse surface treatment and Die-cast aluminum module.

POWER SUPPLY UNIT built in

POWER CABLES neoprene cable 3x0.75mm²

MOUNTING buried base or flange plate

NOTES non-standard heights available on request

Optional Accessories

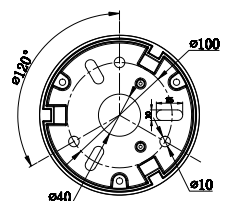
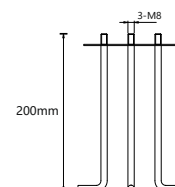

Material: steel
*Need to be purchased separately

Flange plate(Die-cast aluminum)
*Standard configuration

Eclipse

√
Eclipse 1.3/1.4
LT-YS-10W-3000K



IP65 IK06

A A+ A++



POWER / POWER SUPPLY CODE	10W AC220V-240V or (120-277V) ; : () \$ +M
LED COLOUR	- 2700K - 3000K - 4000K
OPTICS	symmetry
LUMEN OUTPUT AT SOURCE	369lm (4000K, 10W)
NO. AND TYPE OF LED	24high-intensity power LEDs 3-step MacAdam (version 24W) 50000h L90 B10 (Ta 25°C)
MATERIAL	Corrosion-resistant aluminium profile, No-Rinse surface treatment and Die-cast aluminum module.
POWER SUPPLY UNIT	built in
POWER CABLES	neoprene cable 3x0.75mm ²
MOUNTING	Surface mount
NOTES	non-standard heights available on request

Optional Accessories

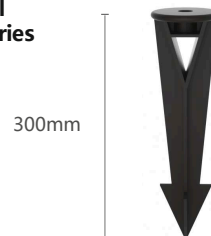

GS Ground Stake1.0
Material: PC

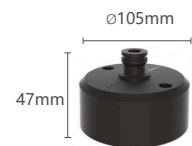

SB Surface Base Mount

Eclipse

√
Eclipse 1.5
LT-YS-2.5W-3000K

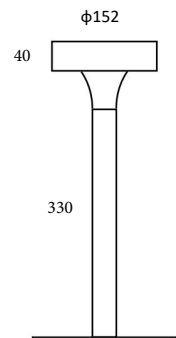

POWER / POWER SUPPLY CODE	2.5W
LED COLOUR	- 2700K - 3000K - 4000K
OPTICS	symmetry
LUMEN OUTPUT AT SOURCE	103lm (3000K, 2.5W)
NO. AND TYPE OF LED	10high-intensity power LEDs 3-step MacAdam
MATERIAL	Corrosion-resistant aluminium profile, No-Rinse surface treatment and Die-cast aluminum module.
POWER SUPPLY UNIT	built in
BATTERY	5000MA.H
DIMMING	0-100%



TYPE-C usb line

Optional Accessories



RAL 9017



RAL 3028



RAL 8011



RAL 6019



LI-TIAN LIGHTING

Shadow

Shadow LED Path Light
LT-YZ-300



A A+ A++



IP65

RAL-Black

POWER / POWER SUPPLY CODE	10W AC220V-240V or (120-277V) ; : () \$ +M
----------------------------------	--

LED COLOUR	- 2700K - 3000K - 4000K
-------------------	-------------------------------

OPTICS	symmetry
---------------	----------

LUMEN OUTPUT AT SOURCE	460lm (4000K, 10W)
-------------------------------	--------------------

NO. AND TYPE OF LED	20high-intensity power LEDs 3-step MacAdam (version 24W) 50000h L90 B10 (Ta 25°C)
----------------------------	---

MATERIAL	Corrosion-resistant aluminium profile, No-Rinse surface treatment and Die-cast aluminum module.
-----------------	---

POWER SUPPLY UNIT	built in
--------------------------	----------

POWER CABLES	neoprene cable 3x0.75mm ²
---------------------	--------------------------------------

MOUNTING	Surface mount
-----------------	---------------

NOTES	non-standard heights available on request
--------------	---

Optional Accessories



GS Ground Stake1.0
Material: PC

JB Junction Box Mount

SB Surface Base Mount

Shadow

Shadow LED Wall Light
LT-YZ-301



A A+ A++



IP65

RAL-Black

POWER / POWER SUPPLY CODE 10W AC220V-240V or (120-277V)
; : () \$ +M

LED COLOUR - 2700K
- 3000K
- 4000K

OPTICS symmetry

LUMEN OUTPUT AT SOURCE 460lm (4000K, 10W)

NO. AND TYPE OF LED 20high-intensity power LEDs 3-step MacAdam (version 24W) 50000h L90 B10 (Ta 25°C)

MATERIAL Corrosion-resistant aluminium profile, No-Rinse surface treatment and Die-cast aluminum module.

POWER SUPPLY UNIT built in

POWER CABLES neoprene cable 3x0.75mm²

MOUNTING Surface mount

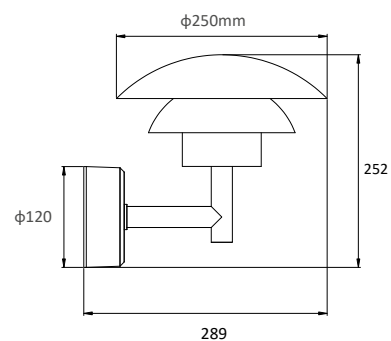



LI-TIAN LIGHTING

Shadow

Shadow Outdoor Hanging Lights

LT-YZ-302



A A+ A++ CE LED TECH IP65 RAL-Black

POWER / POWER SUPPLY CODE 10W AC220V-240V or (120-277V) ; : () \$ +M

LED COLOUR - 2700K
- 3000K
- 4000K

OPTICS symmetry

LUMEN OUTPUT AT SOURCE 460lm (4000K, 10W)

NO. AND TYPE OF LED 20high-intensity power LEDs 3-step MacAdam (version 10W) 50000h L90 B10 (Ta 25°C)

MATERIAL Corrosion-resistant aluminium profile, No-Rinse surface treatment and Die-cast aluminum module.

POWER SUPPLY UNIT built in

POWER CABLES neoprene cable 3x0.75mm²

MOUNTING Hoisting

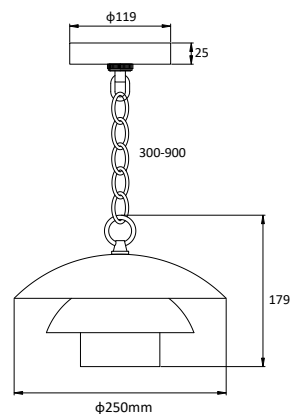

Shadow

Shadow Outdoor Pole Lights
LT-YZ-303/304



A A+ A++ CE LED TECH IP65 RAL-Black

POWER / POWER SUPPLY CODE	20W AC220V-240V or (120-277V) ; : () \$ +M
LED COLOUR	- 2700K - 3000K - 4000K
OPTICS	symmetry
LUMEN OUTPUT AT SOURCE	920lm (4000K, 20W)
NO. AND TYPE OF LED	20high-intensity power LEDs 3-step MacAdam (version 10W) 50000h L90 B10 (Ta 25°C)
MATERIAL	Corrosion-resistant aluminium profile, No-Rinse surface treatment and Die-cast aluminum module.
POWER SUPPLY UNIT	built in
POWER CABLES	neoprene cable 3x0.75mm ²
MOUNTING	

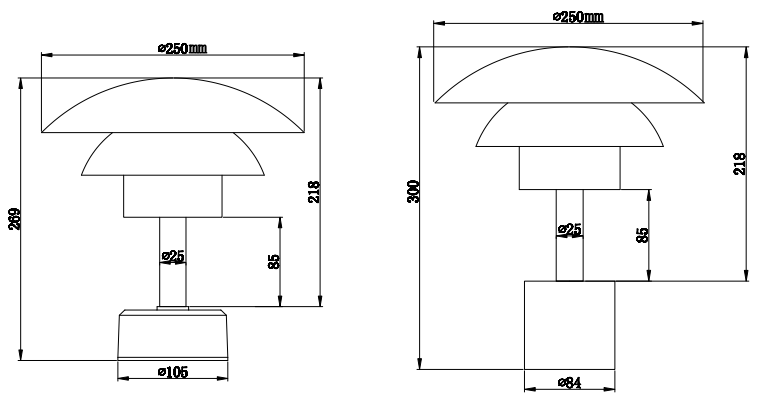

Light distribution map

INTENSITY DISTRIBUTION DIAGRAM
IN C PLANS

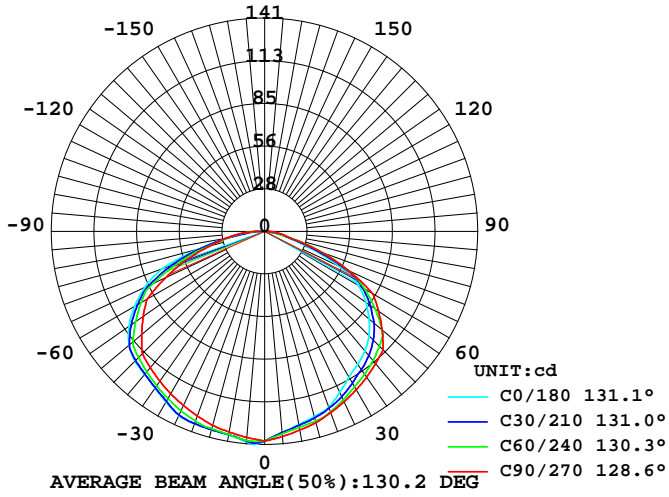

INTENSITY DISTRIBUTION DIAGRAM
IN C PLANS

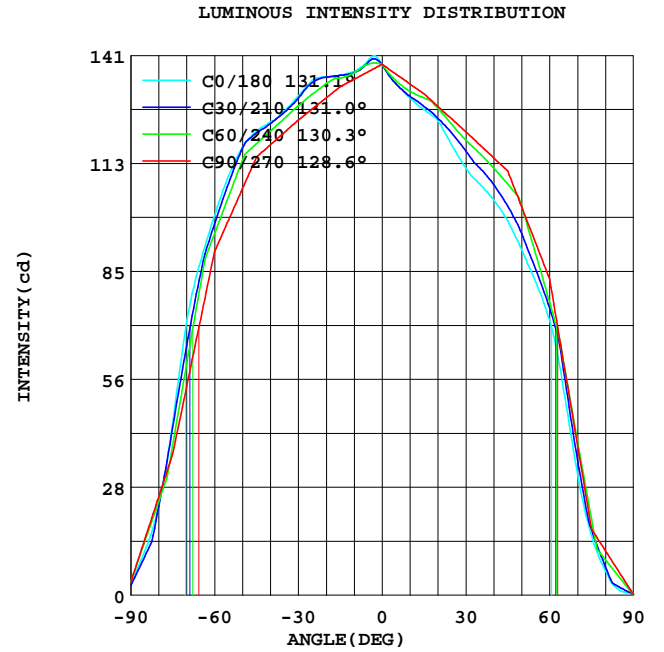

AVERAGE AND CENTER E Figure

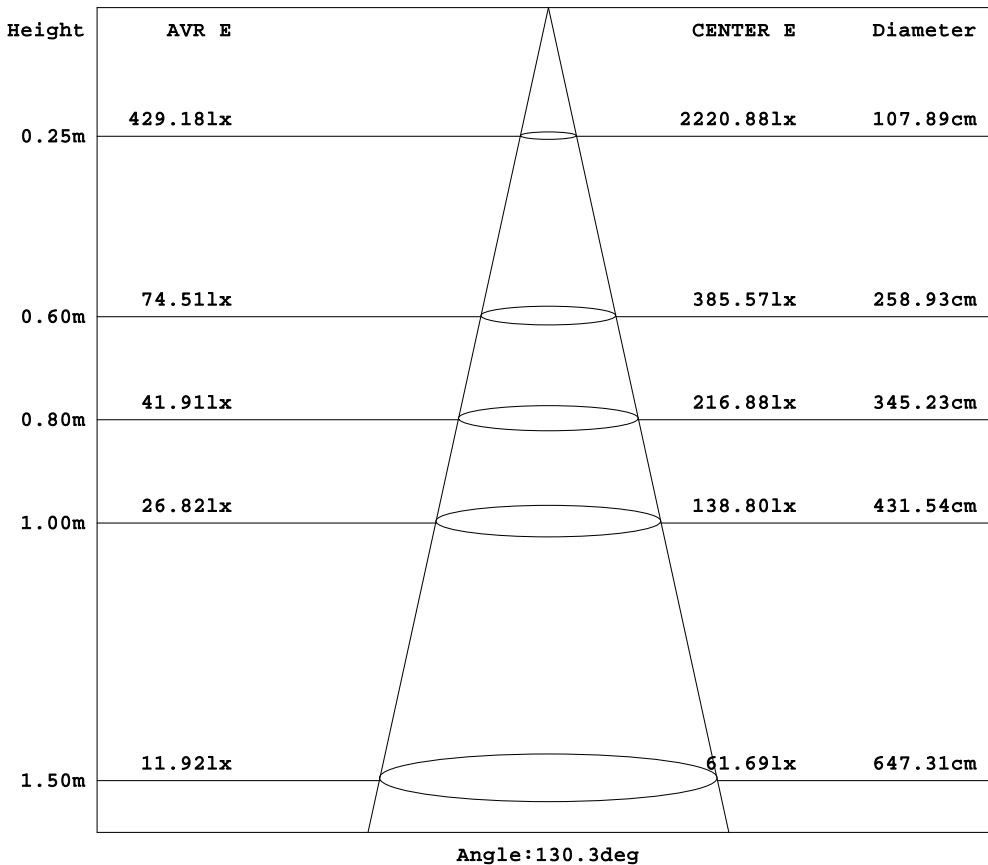





LI-TIAN LIGHTING

PARASOL

LED Pole-top Light

LT-DZ-50W-4000K

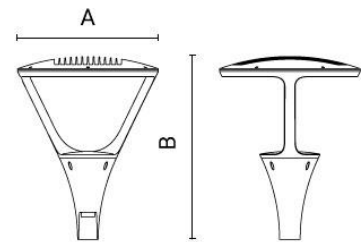

A: Ø 452mm
B: 542mm



POWER / POWER SUPPLY CODE	<input type="checkbox"/> 50W <input type="checkbox"/> 70W <input type="checkbox"/> 100W	220-240V 50/60Hz(120-277V) Black
LED COLOUR	2700K 3000K 4000K	
OPTICS	A - pedestrian zone B - asymmetrical C - footpath D - cycle path	
LUMEN OUTPUT AT SOURCE	6000/8400/12000lm (3000K)	
NO. AND TYPE OF LED	SMD high-intensity power LEDs 3-step MacAdam, 50000h L90 B10 (Ta 25°C)	
MATERIAL	body in die-cast aluminium screen in serigraphed, tempered extra-clear glass	
POWER SUPPLY UNIT	built in	
POWER CABLES	includes 1 m neoprene cable 3x1.00 Ø7.00 mm	
MOUNTING	on pole, Ø60/76 mm	
OVERVOLTAGE PROTECTION	10kV in Common Mode (CM), 6kV in Differential Mode (DM)	
NOTES	Can on request DALI version available on request	

ISOFOOT CANDLE PLOT(TYPE II)

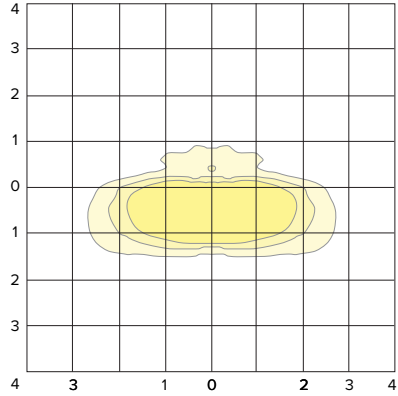

ISOFOOT CANDLE PLOT(TYPE III)

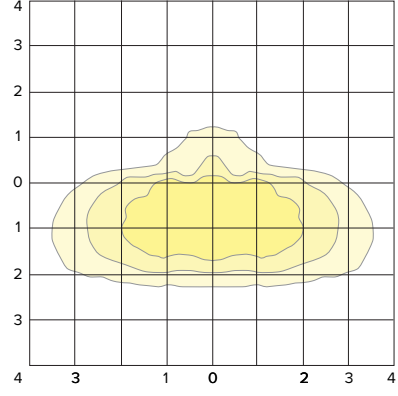

ISOFOOT CANDLE PLOT(TYPE IV)

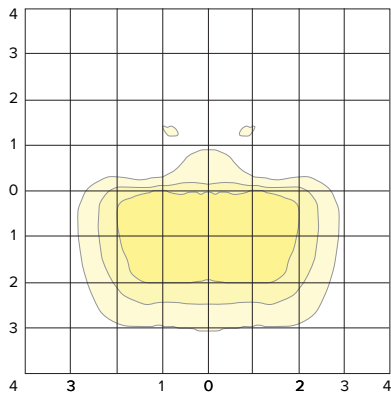

ISOFOOT CANDLE PLOT

Type V Square Medium

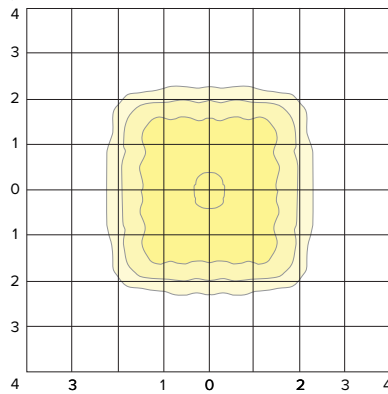

ISOFOOT CANDLE PLOT

(Type V Wide (Round))

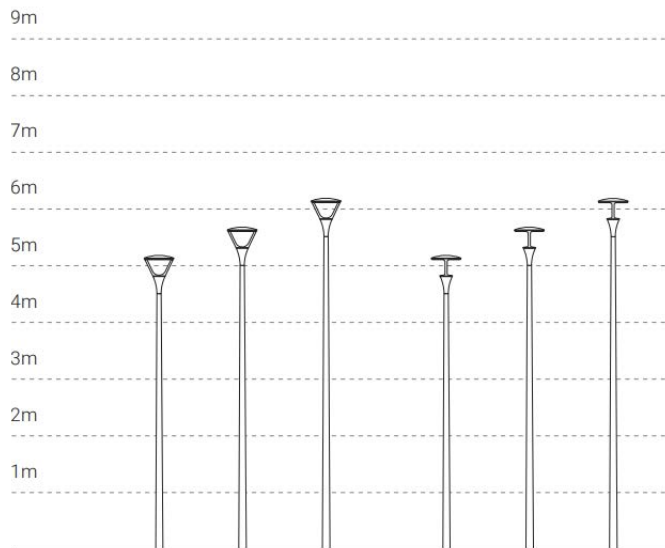
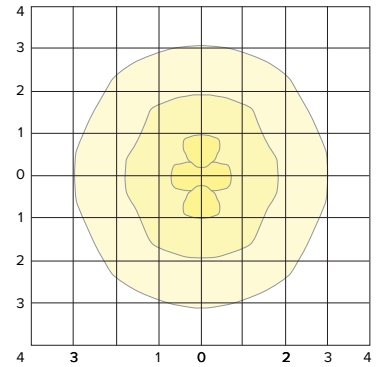



LI-TIAN LIGHTING





LI-TIAN LIGHTING

LEAF

LED Street Light LT-OS-Series

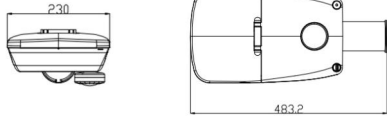

Package Size: L:42*B:27*H:16cm
G W: 3.8kg

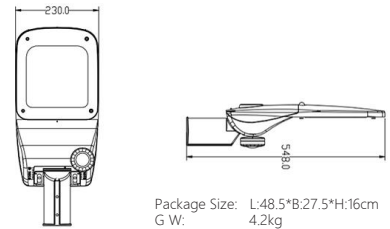

Package Size: L:48.5*B:27.5*H:16cm
G W: 4.2kg



POWER / POWER SUPPLY CODE	50W 70W	220-240V 50/60Hz(120-277V) 1-10V(Dimming)
LED COLOUR	3000K 4000K 5000K	
OPTICS	A - pedestrian zone B - asymmetrical C - footpath D - cycle path	
LUMEN OUTPUT AT SOURCE	6500/9100lm (3000K)	
NO. AND TYPE OF LED	SMD high-intensity power LEDs 3-step MacAdam, 50000h L90 B10 (Ta 25°C)	
POWER SUPPLY UNIT	built in	
POWER CABLES	includes 1 m neoprene cable 3x1.00 Ø7.00 mm	
MOUNTING	on pole, Ø60mm	
OVERVOLTAGE PROTECTION	10kV in Common Mode (CM), 6kV in Differential Mode (DM)	
MATERIAL	Die-cast aluminium body (EN 47100) Double layer polyester powder paint resistant to corrosion and salt spray fog	
NOTES	Can on request DALI version available on request	

POWER / POWER SUPPLY CODE	100W	220-240V 50/60Hz(120-277V) 1-10V(Dimming)
LED COLOUR	3000K 4000K 5000K	
OPTICS	A - pedestrian zone B - asymmetrical C - footpath D - cycle path	
LUMEN OUTPUT AT SOURCE	13000lm (3000K)	
NO. AND TYPE OF LED	SMD high-intensity power LEDs 3-step MacAdam, 50000h L90 B10 (Ta 25°C)	
POWER SUPPLY UNIT	built in	
POWER CABLES	includes 1 m neoprene cable 3x1.00 Ø7.00 mm	
MOUNTING	on pole, Ø60mm	
OVERVOLTAGE PROTECTION	10kV in Common Mode (CM), 6kV in Differential Mode (DM)	
MATERIAL	Die-cast aluminium body (EN 47100) Double layer polyester powder paint resistant to corrosion and salt spray fog	
NOTES	Can on request DALI version available on request	

LT-OS		Nominal Watts		CCT		Distribution		Voltage		Options
Model										
LT-OS	LEAF	50W	6500LM	3K7	3000K, 70 CRI	2	Type II	UNV	120-277V	<ul style="list-style-type: none"> Twist-lock photocell. Motion sensor. 5-pin wireless photoelectric control for added dimming feature. 7-pin wireless photoelectric control for dimming and additional I/O connections for customer use
		100W	13000M	4K7	4000K, 70 CRI	3	Type III	NV	220-240V	
		150W	19500LM			4	Type IV	347	347V	
		200W	26000LM			4W	Type IV Wide	480	480V	
						5QM	Type V Square Medium	DALI	220-240V	
						5W	Type V Wide (Round)	Consult factory		



LI-TIAN LIGHTING

LEAF

LED Street Light LT-OS-Series

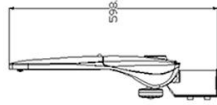

Package Size: L:54.5*B:30.5*H:16cm
G W: 5.5kg

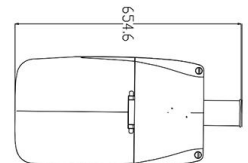
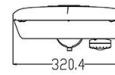

Package Size: L:61.5*B:37.5*H:18.5cm



POWER / POWER SUPPLY CODE	150W 220-240V 50/60Hz(120-277V) 1-10V(Dimming)
LED COLOUR	3000K 4000K 5000K
OPTICS	A - pedestrian zone B - asymmetrical C - footpath D - cycle path
LUMEN OUTPUT AT SOURCE	19500lm (3000K)
NO. AND TYPE OF LED	SMD high-intensity power LEDs 3-step MacAdam, 50000h L90 B10 (Ta 25°C)
POWER SUPPLY UNIT	built in
POWER CABLES	includes 1 m neoprene cable 3x1.00 Ø7.00 mm
MOUNTING	on pole, Ø60mm
OVERVOLTAGE PROTECTION	10kV in Common Mode (CM), 6kV in Differential Mode (DM)
MATERIAL	Die-cast aluminium body (EN 47100) Double layer polyester powder paint resistant to corrosion and salt spray fog
NOTES	Can on request DALI version available on request

POWER / POWER SUPPLY CODE	200W 220-240V 50/60Hz(120-277V) 1-10V(Dimming)
LED COLOUR	3000K 4000K 5000K
OPTICS	A - pedestrian zone B - asymmetrical C - footpath D - cycle path
LUMEN OUTPUT AT SOURCE	26000lm (3000K)
NO. AND TYPE OF LED	SMD high-intensity power LEDs 3-step MacAdam, 50000h L90 B10 (Ta 25°C)
POWER SUPPLY UNIT	built in
POWER CABLES	includes 1 m neoprene cable 3x1.00 Ø7.00 mm
MOUNTING	on pole, Ø60mm
OVERVOLTAGE PROTECTION	10kV in Common Mode (CM), 6kV in Differential Mode (DM)
MATERIAL	Die-cast aluminium body (EN 47100) Double layer polyester powder paint resistant to corrosion and salt spray fog
NOTES	Can on request DALI version available on request

LT-OS		Nominal Watts		CCT		Distribution		Voltage		Options
Model										
LT-OS	LEAF	50W	6500LM	3K7	3000K, 70 CRI	2	Type II	UNV	120-277V	<ul style="list-style-type: none"> • Twist-lock photocell. • Motion sensor. • 5-pin wireless photoelectric control for added dimming feature. • 7-pin wireless photoelectric control for dimming and additional I/O connections for customer use
		100W	13000M	4K7	4000K, 70 CRI	3	Type III	NV	220-240V	
		150W	19500LM	5K7	5000K, 70 CRI	4	Type IV	347	347V	
		200W	26000LM			4W	Type IV Wide	480	480V	
						5QM	Type V Square Medium	DALI	220-240V	
						5W	Type V Wide (Round)	Consult factory		

ISOFOOT CANDLE PLOT(TYPE II)

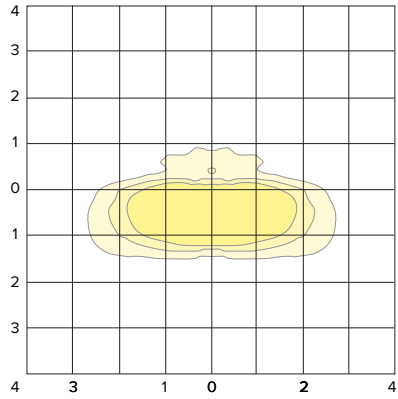

ISOFOOT CANDLE PLOT(TYPE III)

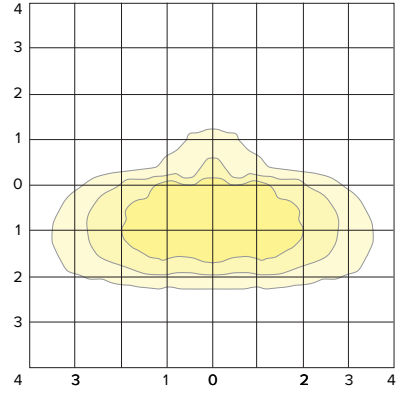

ISOFOOT CANDLE PLOT(TYPE IV)

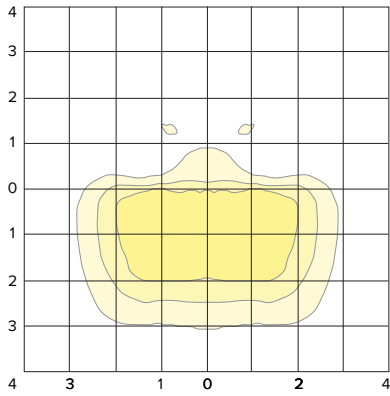

**ISOFOOT CANDLE PLOT
Type V Square Medium**

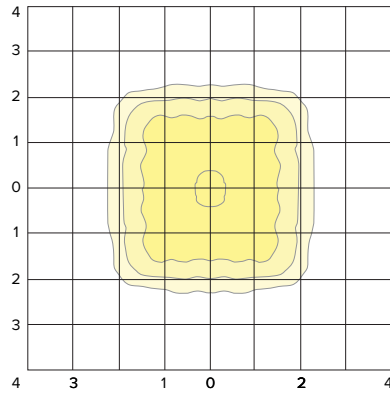

**ISOFOOT CANDLE PLOT
(Type V Wide (Round))**

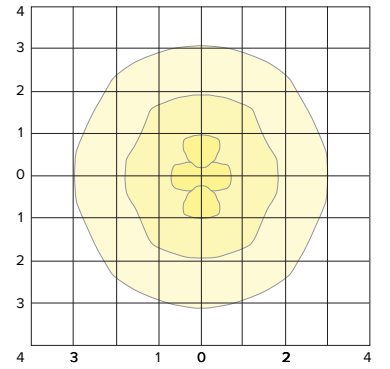





LI-TIAN LIGHTING

LED Street Light

LT-OK-Series



CE LED TECH IP66 IK08 kg 6.7
A A+ A++



CE LED TECH IP66 IK08 kg 10.5
A A+ A++

POWER / POWER SUPPLY CODE	100W 150W 200W	220-240V 50/60Hz(120-277V) 1-10V(Dimming)
LED COLOUR	3000K 4000K 5000K	
OPTICS	A - TYPE II B - TYPE III C - TYPE IV D - TYPE V	
LUMEN OUTPUT AT SOURCE	15000/22500/30000lm (3000K)	
NO. AND TYPE OF LED	SMD high-intensity power LEDs 3-step MacAdam, 50000h L90 B10 (Ta 25°C)	
POWER SUPPLY UNIT	built in	
POWER CABLES	includes 1 m neoprene cable 3x1.00 Ø7.00 mm	
MOUNTING	on pole, Ø60mm	
OVERVOLTAGE PROTECTION	10kV in Common Mode (CM), 6kV in Differential Mode (DM)	
MATERIAL	Die-cast aluminium body (EN 47100) Double layer polyester powder paint resistant to corrosion and salt spray fog	
NOTES	1-Can on request DALI version available on request 2-3 Pin Twistlock PhotocontrolReceptacle 3-37 in Twistlock PhotocontrolReceptacle 4-Integrated Sensor for ON/OFF Operation, 12' - 50' Mounting Height	

POWER / POWER SUPPLY CODE	240W 300W	220-240V 50/60Hz(120-277V) 1-10V(Dimming)
LED COLOUR	3000K 4000K 5000K	
OPTICS	A - TYPE II B - TYPE III C - TYPE IV D - TYPE V	
LUMEN OUTPUT AT SOURCE	36000/45000lm (3000K)	
NO. AND TYPE OF LED	SMD high-intensity power LEDs 3-step MacAdam, 50000h L90 B10 (Ta 25°C)	
POWER SUPPLY UNIT	built in	
POWER CABLES	includes 1 m neoprene cable 3x1.00 Ø7.00 mm	
MOUNTING	on pole, Ø60mm	
OVERVOLTAGE PROTECTION	10kV in Common Mode (CM), 6kV in Differential Mode (DM)	
MATERIAL	Die-cast aluminium body (EN 47100) Double layer polyester powder paint resistant to corrosion and salt spray fog	
NOTES	1-Can on request DALI version available on request 2-3 Pin Twistlock PhotocontrolReceptacle 3-37 in Twistlock PhotocontrolReceptacle 4-Integrated Sensor for ON/OFF Operation, 12' - 50' Mounting Height	

OPTICS

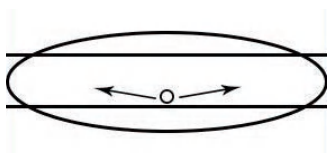

TYPE II

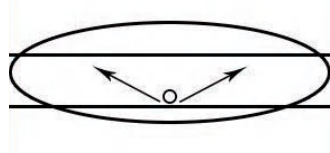

TYPE III

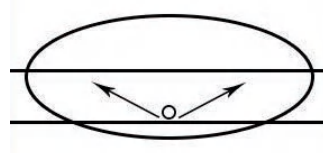

TYPE IV

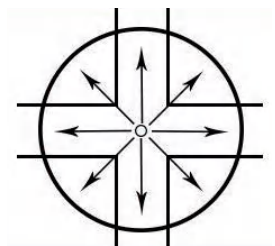

TYPE V



LI-TIAN LIGHTING

MOUNTING BRACKET OPTIONS

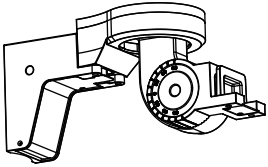

Field-rotatable Optics

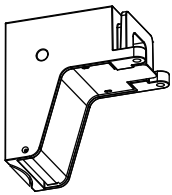
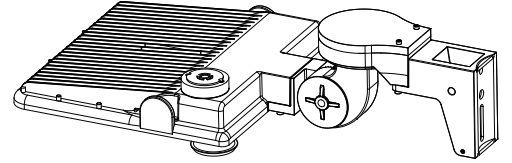

Arm mounting

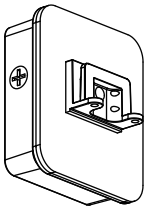
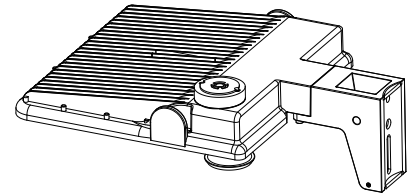

Wall mounting

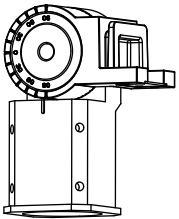
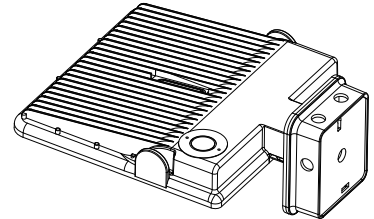

Slip Fitter mounting

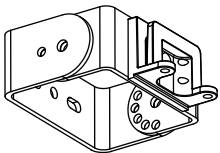
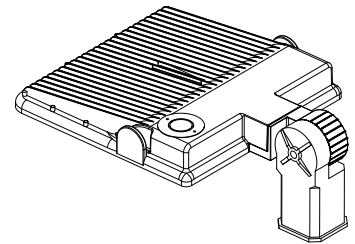

Trunnion mounting

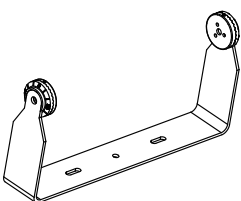
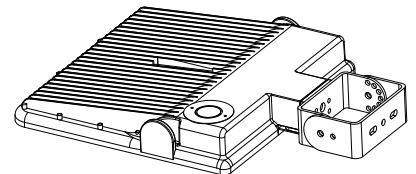

U Bracket mounting

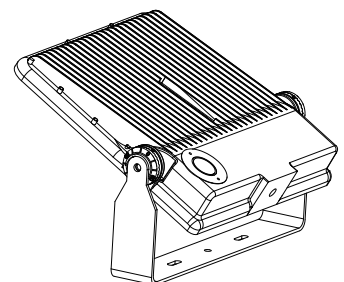



LI-TIAN LIGHTING



POPLAR

LED Wall Light

LT-BY-Series

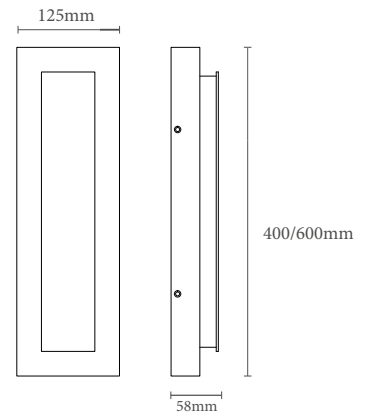
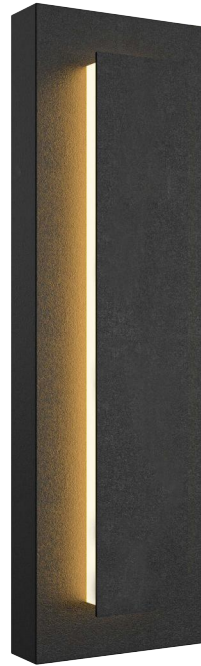

CE LED TECH IP65 IK06
A A+ A++ RAL

POWER / POWER SUPPLY CODE	20W AC220V-240V or (120-277V) 30W
LED COLOUR	- 2700K - 3000K - CIR>90
OPTICS	Side light
LUMEN OUTPUT AT SOURCE	600/900lm (3000K)
NO. AND TYPE OF LED	SMD high-intensity power LEDs 3-step MacAdam (version 24W) 50000h L90 B10 (Ta 25°C)
MATERIAL	Aluminum+PMMA(20mm)
LENS	Impact-resistant, UV stabilized frosted acrylic lensing
POWER SUPPLY UNIT	built in
POWER CABLES	neoprene cable 3x0.75mm ²
MOUNTING	Wall
NOTES	*non-standard heights available on request *DALI Dimming *1-10V Dimming

Finish



Logo



willow



grape



Plum

BLADE

LED Outdoor Wall Light

LT-WW-18

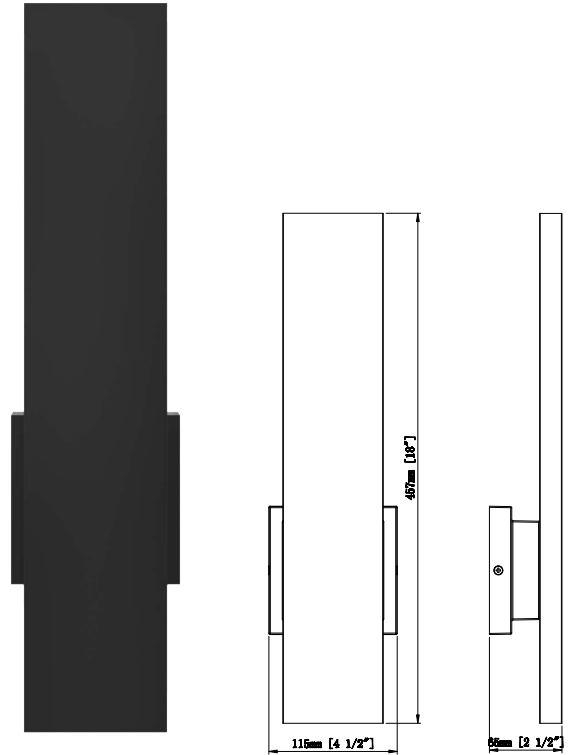

CE LED ETC IP65 IK06
A A+ A++ RAL

POWER / POWER SUPPLY CODE	20W AC220V-240V or (120-277V)
LED COLOUR	- 2700K - 3000K - CIR>80+
OPTICS	Symmetric
LUMEN OUTPUT AT SOURCE	1200lm (3000K)
NO. AND TYPE OF LED	SMD high-intensity power LEDs 3-step MacAdam (version 20W) 50000h L90 B10 (Ta 25°C)
MATERIAL	Aluminum
FINISH	Powder Coat(Black and Bronze)SELECTABLE
POWER SUPPLY UNIT	built in
POWER CABLES	neoprene cable 3x0.75mm ²
MOUNTING	Wall
NOTES	*Dimmable with most LED compatible ELV & TRIAC *dimmers + 1-10V

Fully Shielded Wall Pack Light

LT-XT-06-Series

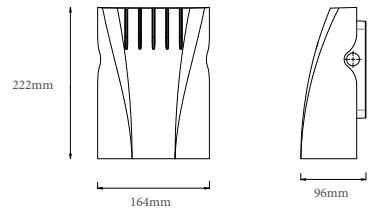

CE, RoHS, LED TPC, IP65, IK06, A, A+, A++, RAL

POWER / POWER SUPPLY CODE	-15W AC220V-240V or (120-277V) -20W -25W
LED COLOUR	- 3000K CRI>80 - 4000K - 5000K
OPTICS	Asymmetric
LUMEN OUTPUT AT SOURCE	1519/2200/2808lm (3000K)
NO. AND TYPE OF LED	1 COB high-intensity power LED 3-step MacAdam, 50000h L90 B10 (Ta 25°C)
MATERIAL	Die-cast aluminum, Polyester powder coating
LENS	PC reflector+4mm tempered glass
POWER SUPPLY UNIT	built in
POWER CABLES	neoprene cable 3x0.75mm ²
MOUNTING	Wall
NOTES	*DALI Dimming *1-10V Dimming

INTENSITY DISTRIBUTION DIAGRAM
IN C PLANS

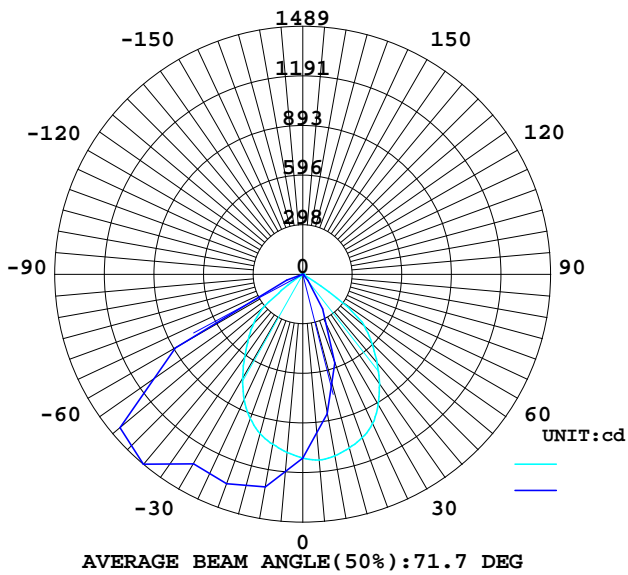

AVERAGE AND CENTER E Figure

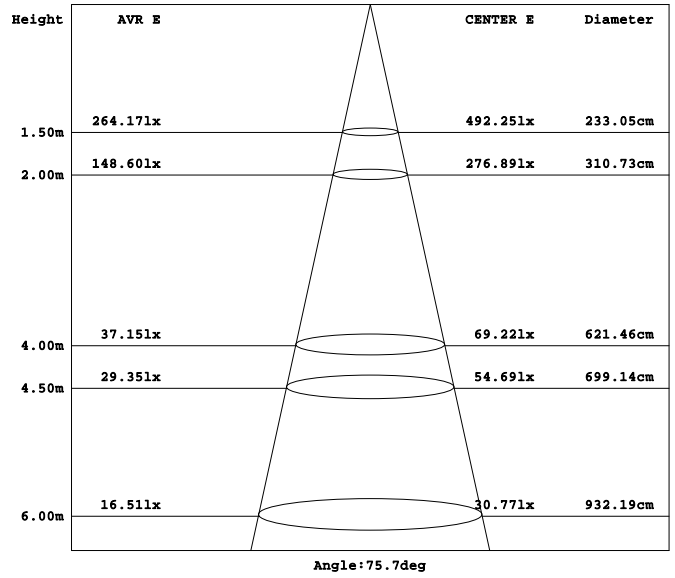

ACCESSORIES

Options

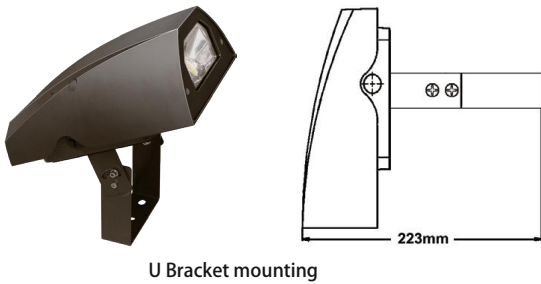

Mini Wall Pack Light

LT-XT-08-Series

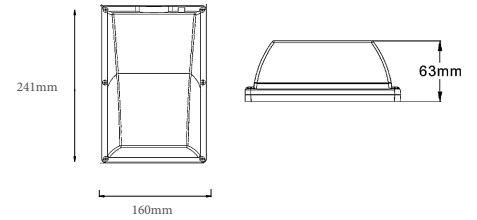

POWER / POWER SUPPLY CODE	-15W AC220V-240V or (120-277V) -25W -30W
LED COLOUR	- 3000K CRI>80 - 4000K - 5000K
OPTICS	120°
LUMEN OUTPUT AT SOURCE	1335/2225/22670lm (3000K)
NO. AND TYPE OF LED	SMD high-intensity power LED 3-step MacAdam, 50000h L90 B10 (Ta 25°C)
MATERIAL	Die-cast aluminum, Polyester powder coating
LENS	Milky white polycarbonate
POWER SUPPLY UNIT	built in
POWER CABLES	neoprene cable 3x0.75mm ²
MOUNTING	Wall
NOTES	*DALI Dimming *1-10V Dimming *Photocell



LI-TIAN LIGHTING

Wall luminaires with directed light

LT-SL-Series

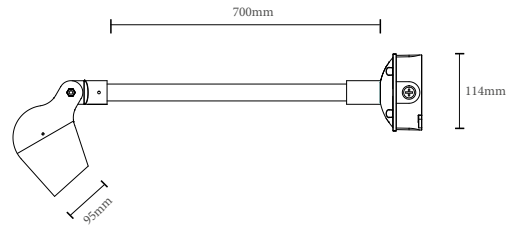

POWER / POWER SUPPLY	10W / 20W Powder coating: bronze	AC220V-240V or (120-277V)
CRI	CRI >90	
LED COLOUR	- 2700K - 3000K - 4000K	
OPTICS	- optical range 15° / 23° / 36° / 60° / 40*70°	
LUMEN OUTPUT AT SOURCE	1000lm / 2000lm (4000K, CRI 90)	
NO. AND TYPE OF LED	1 COB high-intensity power LED 3-step MacAdam, 50000h L90 B10 (Ta 25°C)	
MATERIAL	body in Powder coating anticorodal aluminium screen in tempered, transparent extra-clear glass	
POWER CABLES	neoprene cable 3x0.75	
MOUNTING	surface mounted (ceiling, wall, ground, spike, pole)	
NOTES	Honeycomb louvre available on request	

Accessories



Extension arm

Material: Aluminum profile
Specification: Thickness 4mm, φ25mm
***Length can be customized**

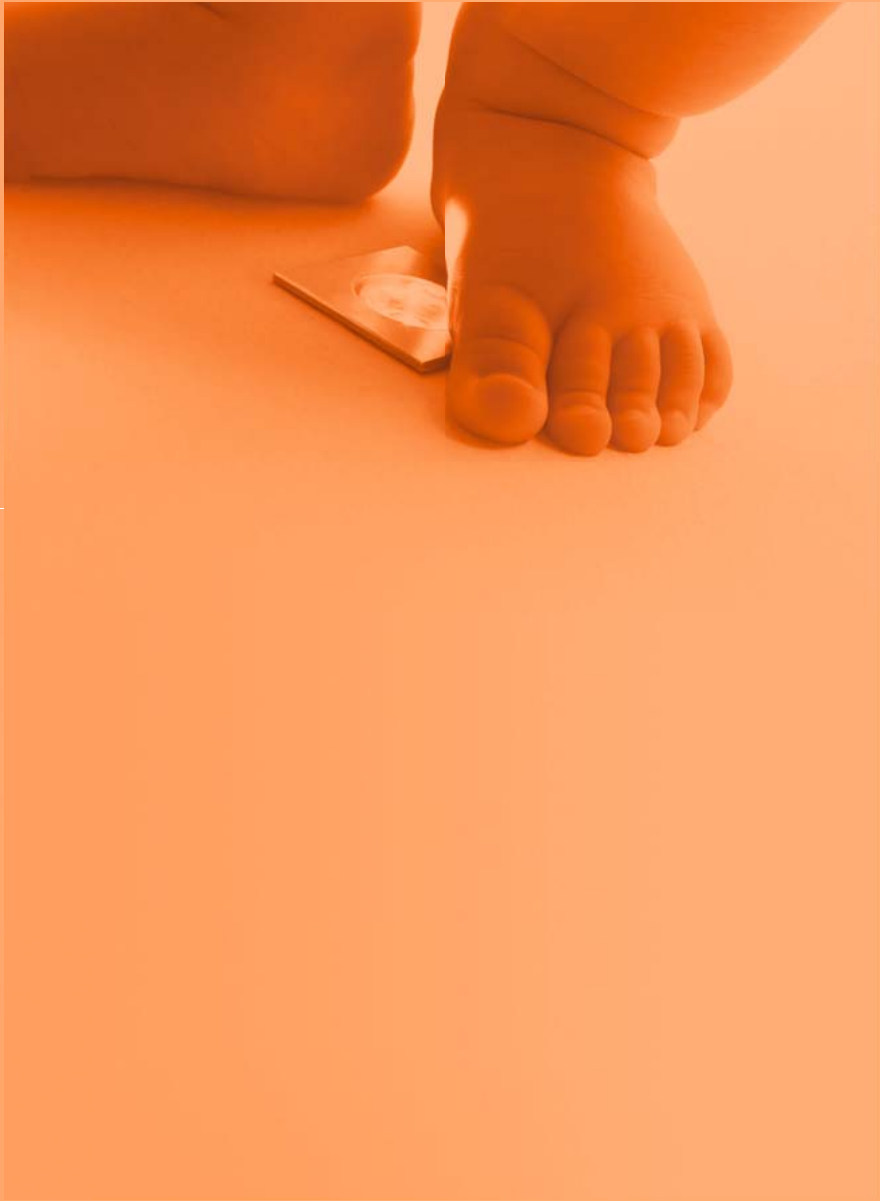

RECESSED

FOR OUTDOOR APPLICATIONS



LED Underground Light

LT-DMD-130-6W

FIXED OPTICS

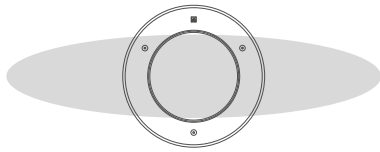
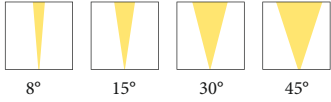

15°x60° optics

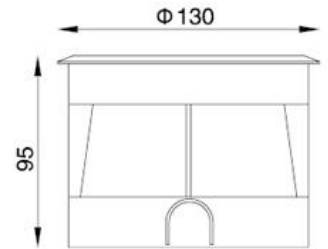

Ø 130 mm
H 95 mm

Ø 120 mm

CE LED ENEC III kg 1000 kg 1.1 IP67 IK08
A A+ A++

POWER / POWER SUPPLY CODE	6W DC 24V
CRI	- CRI >80
LED COLOUR	- 2700K - 3000K - 4000K
OPTICS	V - 8° S - 15° M - 30° L - 45° W - 15°x60°
DELIVERED LUMEN OUTPUT	540 lm (3000K, 700mA, 22°, CRI 80)
NO. AND TYPE OF LED	6 high intensity power LEDs 3-step MacAdam
MATERIAL	body in die-cast aluminium trim in AISI 304 stainless steel screen in serigraphed, tempered, transparent extra-clear glass
POWER CABLES	includes 0.6 m neoprene cable H05RN-F 3x0.75/0.75 Ø6.3 mm
MOUNTING	recessed (wall, ground)

V - 8° CRI 80

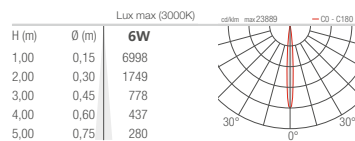

M - 30° CRI 80

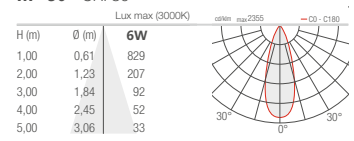

S - 15° CRI 80

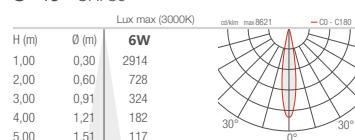

L - 45° CRI 80

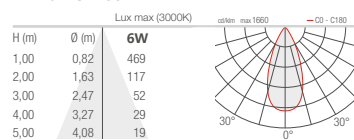

W - 15°x60° CRI 80

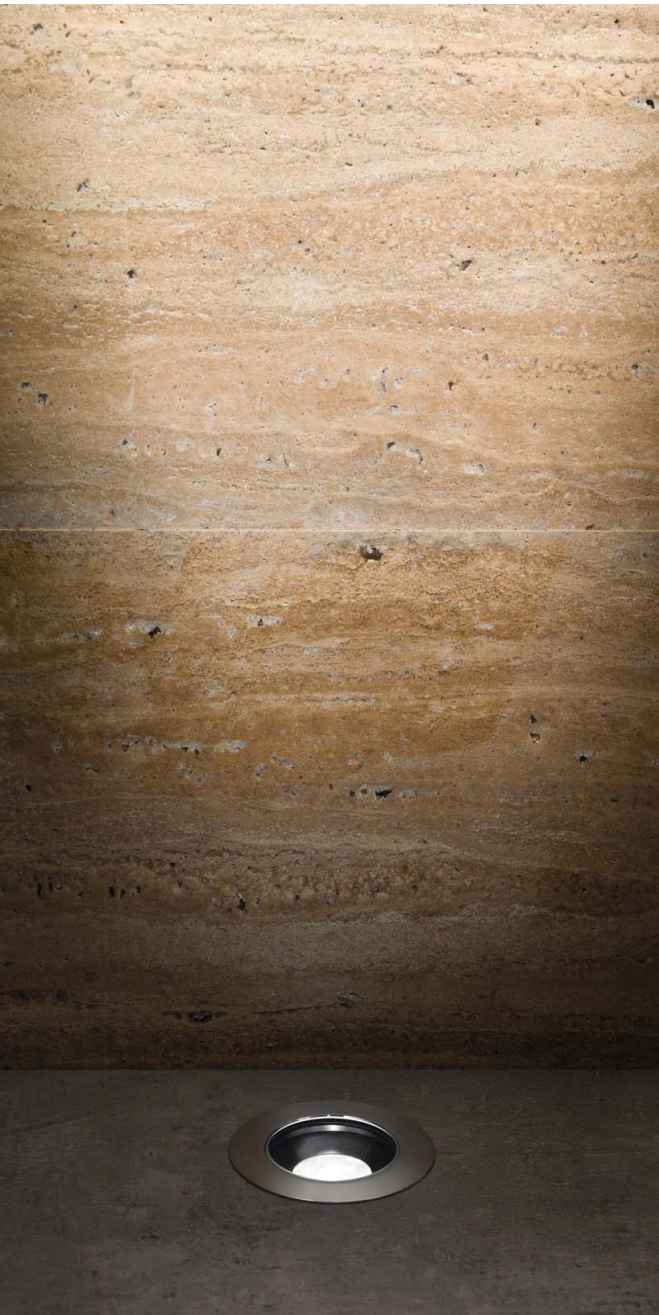
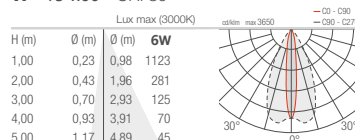



LI-TIAN LIGHTING

LT-DMD-160-9W

FIXED OPTICS

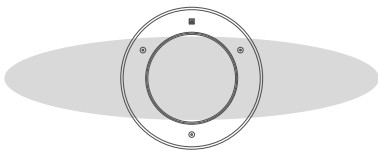
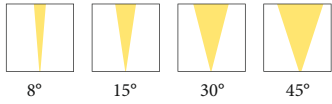

15°x60° optics

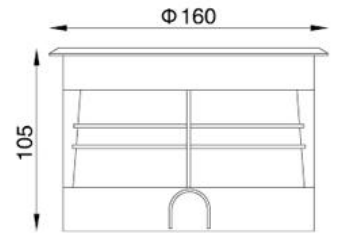

Ø 160 mm H 105 mm Ø 145 mm

CE LED ENEC III kg 1000 kg 1.8 IP67 IK08
A A+ A++

POWER / POWER SUPPLY CODE	9W DC 24V
CRI	- CRI >80
LED COLOUR	- 2700K - 3000K - 4000K
OPTICS	V - 8° S - 15° M - 30° L - 45° W - 15°x60°
DELIVERED LUMEN OUTPUT	810 lm (3000K, 700mA, 22°, CRI 80)
NO. AND TYPE OF LED	9 high intensity power LEDs 3-step MacAdam
MATERIAL	body in die-cast aluminium trim in AISI 304 stainless steel screen in serigraphed, tempered, transparent extra-clear glass
POWER CABLES	includes 0.6 m neoprene cable H05RN-F 3x0.75/0.75 Ø6.3 mm
MOUNTING	recessed (wall, ground)



S - 15° CRI 80

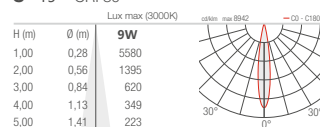

L - 45° CRI 80

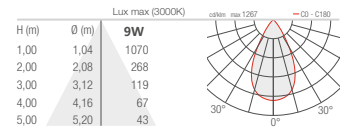

M - 30° CRI 80

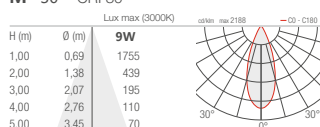



LI-TIAN LIGHTING

LT-DMD-230-18W

FIXED OPTICS

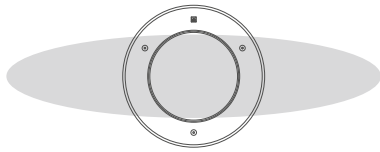
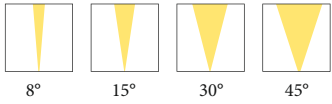

15°x60° optics

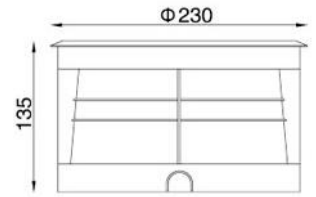

Ø 230 mm
H 135 mm

Ø 220 mm

CE LED ENEC III kg 1000 kg 3.3 IP67 IK08
A A+ A++

POWER / POWER SUPPLY CODE	18W DC 24V
CRI	- CRI >80
LED COLOUR	- 2700K - 3000K - 4000K
OPTICS	V - 8° S - 15° M - 30° L - 45° W - 15°x60°
DELIVERED LUMEN OUTPUT	1620 lm (3000K, 700mA, 22°, CRI 80)
NO. AND TYPE OF LED	18 high intensity power LEDs 3-step MacAdam
MATERIAL	body in die-cast aluminium trim in AISI 304 stainless steel screen in serigraphed, tempered, transparent extra-clear glass
POWER CABLES	includes 0.6 m neoprene cable H05RN-F 3x0.75/0.75 Ø6.3 mm
MOUNTING	recessed (wall, ground)



S - 15°

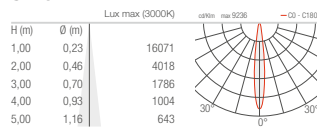

L - 45°

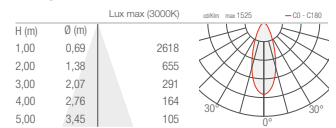



LI-TIAN LIGHTING

LT-DMD-260-24W

FIXED OPTICS

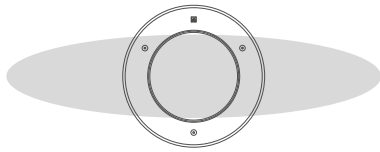
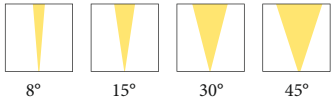

15°x60° optics

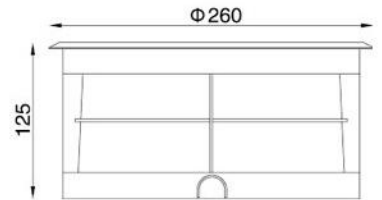

Ø 260mm
H 125mm

Ø 240mm

CE LED ENEC III kg 1000 kg 4.2 IP67 IK08
A A+ A++

POWER / POWER SUPPLY CODE	24W DC 24V
CRI	- CRI >80
LED COLOUR	- 2700K - 3000K - 4000K
OPTICS	V - 8° S - 15° M - 30° L - 45° W - 15°x60°
DELIVERED LUMEN OUTPUT	2160 lm (3000K, 700mA, 22°, CRI 80)
NO. AND TYPE OF LED	24 high intensity power LEDs 3-step MacAdam
MATERIAL	body in die-cast aluminium trim in AISI 304 stainless steel screen in serigraphed, tempered, transparent extra-clear glass
POWER CABLES	includes 0.6 m neoprene cable H05RN-F 3x0.75/0.75 Ø6.3 mm
MOUNTING	recessed (wall, ground)



S - 15° CRI 80

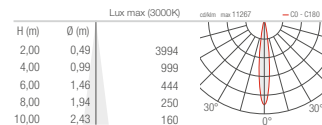

W - 15°x60° CRI 80

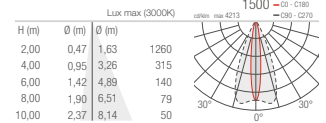

M - 30° CRI 80

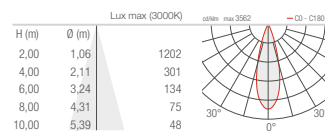



LI-TIAN LIGHTING



Zhongshan Litian Lighting Co., Ltd

Tel : +86-760-23757187

Fax : +86-760-23757185

E-mail: annamiss1981@china-litianled.com

Website: www.ilitianled.com

ADD: Block B 4/F, No.2 Yihui 2nd Road Maohui Industry,
Sisha, Henglan Town, Zhongshan City, Guangdong Province, China